

# SAMYUNG ENC

## N430/NF430 USER MANUAL





# SAFETY INSTRUCTIONS



This device's electronic chart system(ECS) is developed for the navigational aid only and chart itself does not obtain any approvals; has not been certified from the government authorities. If operator needs safe navigation then must use an official chart that has been approved by government agencies also operator is fully responsible for using this device

Please read through this manual before the first operation. If you have any questions, please contact the customer service or your local dealer or distributor  
Extensive exposure to heat may result in damage to the chart plotter.

Connection to the power source with reversed polarity will damage the chart plotter severely. This damage is not covered by the warranty.

Do not disassemble. The chart plotter contains dangerous high voltage circuits which only experienced technicians must handle

Exposure of the display to UV rays may shorten the life of the liquid crystals used in you plotter. This limitation is due to the current technology of the LCD display.

Avoid overheating which may cause loss of contrast and, in extreme case, a darkening of the screen. Problems which occur from over heating are reversible when temperature decreases.



## Screen Cleaning Precautions











Cleaning your chart plotter screen is a very important operation and must be done carefully. The following is the cleaning procedure.

You use a tissue or lens tissue and a cleaning spray containing Isopropanol (a normal spray cleaner sold for PC screens). Fold the tissue or lens tissue into a triangular shape, moisten the tip and use the index finger behind a corner to move the tissue across the surface, in overlapping side to side strokes. If the tissue is too wet, a noticeable wet film will be left in its path and you will need to repeat the process. If too dry, the tissue won't glide easily, and may damage the surface.



If you require technical advice or assistance, contact your nearest samyung enc office or visit our website, [www.samyungenc.com](http://www.samyungenc.com).









<b>1 Introduction .....</b>	<b>9</b>
<b>1-1 General Information .....</b>	<b>9</b>
<b>1-2 Specification .....</b>	<b>9</b>
<b>1-3 Packing List .....</b>	<b>10</b>
<b>1-4 Optional Accessories .....</b>	<b>10</b>
<b>2 Getting Started.....</b>	<b>11</b>
<b>2-1 Installation .....</b>	<b>11</b>
2-1-1 Bracket Mounting.....	11
2-1-2 Flush Mounting .....	11
<b>2-2 Keys .....</b>	<b>12</b>
<b>2-3 NAVIONICS SD Card .....</b>	<b>13</b>
<b>2-4 Chart Selection .....</b>	<b>13</b>
<b>2-5 Simulate Mode .....</b>	<b>13</b>
<b>2-6 Data Bar .....</b>	<b>13</b>
<b>2-7 Compass .....</b>	<b>15</b>
<b>2-8 Multi Window Display.....</b>	<b>16</b>
<b>3 General Operation .....</b>	<b>18</b>
<b>3-1 Power on and off .....</b>	<b>18</b>
<b>3-2 Brightness, night mode and Background .....</b>	<b>18</b>
<b>3-3 The page window .....</b>	<b>19</b>
 <b>3-4 Chart.....</b>	<b>21</b>
3-4-1 Chart window .....	21
3-4-2 Latitude and longitude.....	22
3-4-3 Chart scale .....	22
3-4-4 Finding a chart symbol .....	22
3-4-5 S-Map search .....	23
3-4-6 Chart symbols and information.....	23
3-4-7 Introduction to navigating.....	23
3-4-8 Going to a waypoint or to a point on the chart.....	24
3-4-9 Following a route .....	24
3-4-10 Distance and bearing calculator .....	25
3-4-11 Projected course .....	25
3-4-12 Finding a chart symbol.....	25
3-4-13 Tracks & Log Settings in the chart window .....	26
 <b>3-5 Sonar .....</b>	<b>27</b>
3-5-1 Interpreting the display .....	27
3-5-2 Mode .....	27
3-5-3 Single and Dual frequency fish finding .....	28
3-5-4 Range.....	28
3-5-5 Gain .....	29

	3-5-6 Sonar window display .....	30
	3-5-7 No plit .....	30
	3-5-8 Split zoom and Full Screen zoom .....	31
	3-5-9 Split bottom .....	31
	3-5-10 Split 50/200 .....	32
	3-5-11 Split A-Scope .....	32
	<b>3-6 Highway .....</b>	<b>33</b>
	<b>3-7 Gauges .....</b>	<b>33</b>
	<b>3-8 Waypoints .....</b>	<b>34</b>
	3-8-1 Creating a new waypoint .....	34
	3-8-2 Moving a waypoint .....	34
	3-8-3 Editing an existing waypoint .....	34
	3-8-4 Deleting a waypoint .....	35
	3-8-5 Find a waypoint .....	35
	3-8-6 Sort Waypoints .....	35
	3-8-7 Deleting all waypoints .....	35
	<b>3-9 Routes .....</b>	<b>36</b>
	3-9-1 Managing a route from the chart window .....	36
	3-9-2 Managing a route from the route window .....	37
	<b>3-10 Satellites .....</b>	<b>38</b>
	3-10-1 Satellite information .....	38
	<b>3-11 Tides .....</b>	<b>39</b>
	<b>3-12 AIS .....</b>	<b>40</b>
	3-12-1 Viewing AIS Vessels .....	40
	3-12-2 AIS Windows .....	40
	<b>3-13 DSC .....</b>	<b>42</b>
	3-13-1 1 distress .....	42
	3-13-2 Poll .....	43
	<b>3-14 NAVTEX .....</b>	<b>44</b>
	<b>3-15 Engine Faults .....</b>	<b>44</b>

## 4 Settings .....

	<b>4-1 System Configuration Settings .....</b>	<b>45</b>
	4-1-1 Language .....	45
	4-1-2 Chart Selection .....	45
	4-1-3 Beep volume .....	45
	4-1-4 Auto power .....	45
	4-1-5 Features .....	45
	4-1-6 Factory reset .....	45
	4-1-7 Unit information .....	45
	<b>4-2 Chart Settings .....</b>	<b>46</b>
	4-2-1 Rotation .....	47

	4-2- Palette.....	47
	4-2-3-1 General (NAVIONICS).....	47
	4-2-3-2 General(S-MAP).....	47
	4-2-4-1 Land & Sea (NAVIONICS).....	47
	4-2-4-2 Land & Sea (S-MAP).....	48
	4-2-5 Map datum.....	48
	4-2-6 NMEA datum offset.....	48
	4-2-7 Map shift.....	48
	4-2-8 Restore default.....	48
	<b>4-3 GPS Settings.....</b>	<b>49</b>
	4-3-1 GPS Source.....	49
	4-3-2 DGPS Source.....	49
	4-3-3 Static Navigation.....	49
	4-3-4 Speed Filter.....	49
	4-3-5 Course Filter.....	49
	4-3-6 Lat/Lon d.p's.....	49
	4-3-7 Ship speed.....	49
	4-3-8 Magnetic Variation.....	49
	<b>4-4 Track &amp; Log Settings.....</b>	<b>50</b>
	4-4-1 Track.....	50
	4-4-2 Log.....	50
	<b>4-5 Memory Settings.....</b>	<b>51</b>
	4-5-1 Save.....	51
	4-5-2 Load.....	51
	4-5-3 Delete.....	51
	4-5-4 Format.....	52
	4-5-5 Screen Snap Shot.....	52
	<b>4-6 AIS Settings.....</b>	<b>52</b>
	4-6-1 Display Filter.....	53
	4-6-2 Alarm Option.....	53
	4-6-3 Display Option.....	53
	4-6-4 Restore Default.....	53
	<b>4-7 Alarm Settings.....</b>	<b>54</b>
	4-7-1 Deep.....	54
	4-7-2 Shallow.....	54
	4-7-3 Temperature.....	54
	4-7-4 Temperature rate.....	54
	4-7-5 Low battery.....	54
	4-7-6 Navigation alarms.....	54
	4-7-7 AIS.....	54
	4-7-8 DGPS.....	54
	4-7-9 Restore default.....	54
	<b>4-8 Others.....</b>	<b>55</b>
	4-8-1 Simulate.....	55
	4-8-2 Waypoint.....	55
	4-8-3 GPS.....	55
	4-8-4 Units.....	55
	4-8-5 Comms.....	55
	4-8-6 Time.....	55

<b>5 INSTALLATION .....</b>	<b>56</b>
<b>5-1 Options and Accessories.....</b>	<b>56</b>
<b>5-2 Connections .....</b>	<b>57</b>
<b>5-3 Power / Data Cable .....</b>	<b>57</b>
<b>5-4 GPS Antenna.....</b>	<b>57</b>
5-4-1 External Antenna .....	57
5-4-2 The Antenna by using NMEA .....	58
<b>5-5 Sonar.....</b>	<b>59</b>
<b>5-6 NMEA 0183 .....</b>	<b>59</b>
<b>5-7 Setup and Test.....</b>	<b>59</b>



# 1 Introduction

## 1-1 General Information

The chart plotter is a precision-crafted GPS chart Plotter with high-performance receiver for the Global Positioning System constellation of satellites, providing precise location data with a host of navigation features. Some functions require optional units and sensors installed on your boat.

The chart plotter can be connected to external devices with NMEA0183 and NMEA2000 interface and display information. Following are the examples.

- NAVTEX
- AIS receiver
- DSC VHF radio
- Transducer & sensors
- Autopilot

## 1-2 Specification

[N430, NF430]

<b>GENERAL</b>	
Category	Detail
<b>Size</b>	129 mm(H) x 183 mm(W) x 113.5 mm(D)
<b>Display</b>	4.3 "Diagonal, TFT color, 480 x 272 pixels
<b>Supply Voltage</b>	10 ~ 35 V DC
<b>Supply Current</b>	N 430
	NF 430
	13.8 V
	130 mA - LCD no backlighting.
	240 mA - full backlighting.
	13.8 V
	270 mA - LCD no Backlighting
	400 mA - LCD full backlighting
<b>Operating temperature</b>	-10° ~ 50°C
<b>ALARMS</b>	
User set: Arrival radius, anchor, XTE, danger, low battery, loss of DGPS fix, dangerous AIS vessels.	
<b>GPS NAVIGATION</b>	
<b>Chart card</b>	NAVIONICS SD Card
<b>User card</b>	SD Card
<b>Waypoints</b>	Up to 10,000, with default or user defined alphanumeric names up to eight characters.
<b>Routes</b>	100 Routes, with up to 100 points each
<b>Tracks</b>	By time or distance, 10 track of 15,000 points
<b>Chart datums</b>	216 Chart datums, One user-defined map shift.
<b>Chart scale</b>	0.2 to 500 nm for chart (chart dependent) down to 0.005 nm in plotter mode.
<b>COMMUNICATIONS</b>	
<b>NMEA</b>	NMEA 0183 baud : 4800, 9600, 38400
<b>NMEA 0183 Inputs from compatible instruments</b>	DBK, DBS, DBT, DPT, GGA, GLL, GNS, GGA, GSV, HDG, HDT, MDA, MTA, MTW, MWD, MWV, RMC, RPM, VHW, VTG, VWT, ZDA
<b>NMEA 0183 Outputs, for compatible instruments</b>	APA, APB, BWR, GGA, GLL, GSA, GSV, RMB, RMC, VTG, XTE, XDR, ZDA, PLT
<b>NMEA 2000 Outputs, for compatible instruments</b>	Water Speed(128259), Water depth(128267), XTE(129283), NAV. data(129284), NAV. data(129285), COG & SOG(129026), GNSS position(129029), Water temp.(130310)

## 1-3 Packing List

Item List	Part number	
	N430	NF430
Display	N430-E	NF430-E
Bracket	N430-DB	
Display Cover	Z8-2M-05	
Bracket mounting screw	N430-BP	
Protection Cover	N430-CB	
User's Manual(E)	N430-ME	
Quick User Guide(E)	N430-BE	
GPS Antenna Stand type Support	57745	
GPS Antenna + GPS Antenna Support	SAN-60-10	
Fuse	527-2002-1Q	
P7 or P23	X	P7 or P23

## 1-4 Optional Accessories

Model	Part number	Item List
Flush mount Kit (Including screw)	N430-TK	O (OPTION)

## 2 Getting Started

### 2-1 Installation

The chart plotter is supplied with bracket and flush mounting kit. You can choose a method of installation according to your preference.

#### 2-1-1 Bracket Mounting

Before installing ensure the area the bracket is mounted to is strong enough to support the weight of the GPS chart plotter. After the location is found, attach the mounting base to the area using the supplied hardware.

##### Mounting the display unit:

- 1 Hold the display unit and find a groove joint between the display unit and bracket.
- 2 Gently push the display unit into the groove of bracket
- 3 Turn the knob to clockwise to lock.

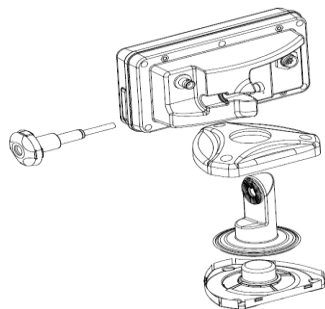

##### Removing the display unit:

- 1 Turn the unit off
- 2 Turn the knob to counter clockwise and pull the display unit out.

#### 2-1-2 Flush Mounting

- 1 Find a location for flush mounting.
- 2 Drill a hole in the area of the cutout area for the blade of jig saw.
- 3 insert and cut out the area on the panel using the jig saw
- 4 Drill four holes for mounting studs.
- 5 Install the mounting studs on the chart plotter and insert them into the mounting hole.
- 6 Attach the chart plotter to the mounting location by attaching the supplied hardware to the mounting studs.



##### Note

- 1 If you flush mount, you need the optional external GPS antenna.
- 2 Before Drilling holes make sure there is enough space to mount the chart plotter there is no obstructions.

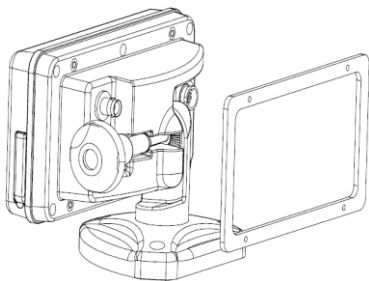

## 2-2 Keys

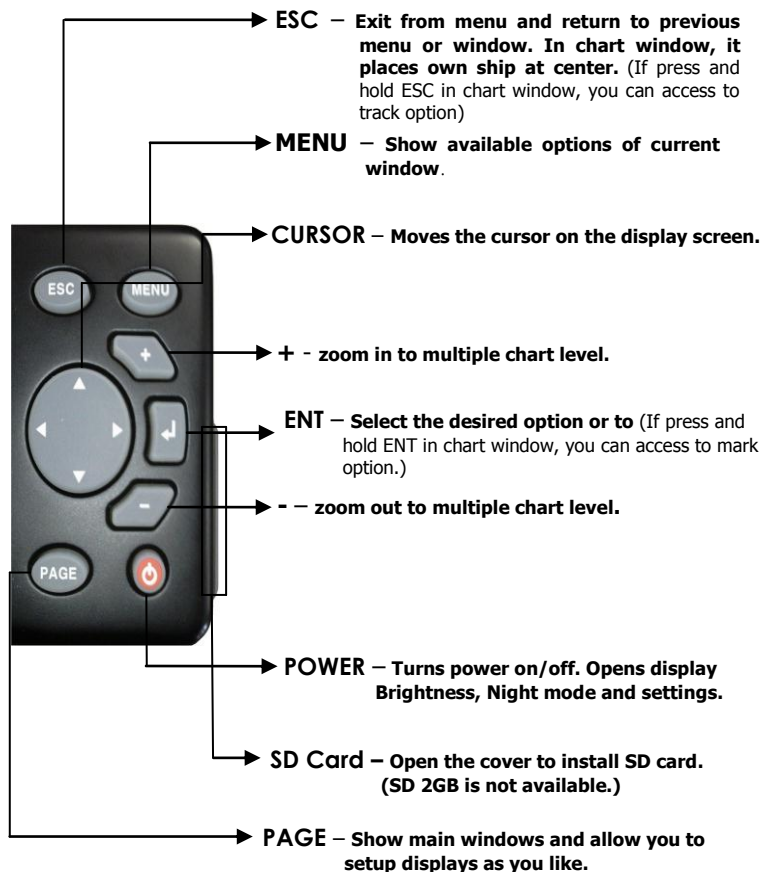

## 2-3 NAVIONICS SD Card

This section provides instructions for inserting and removing NAVIONICS SD card procedure.

### Inserting the SD Card

- 1 Hold the SD card so that you can see the NAVIONICS label.
- 2 Open the door, gently push the SD card into the slot; push the SD card in as far as you hear click sound, then close door.

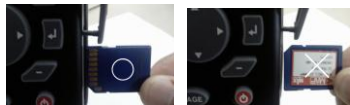

### Removing the SD Card

- 1 Turn off the unit.
- 2 Open the door and push in on the SD card until it is released.
- 3 Close the door.

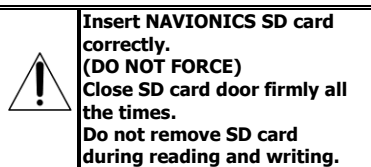

## 2-4 Chart Selection

A user can select a map between NAVIONICS and S-MAP.

A user can select a map as follow instruction,

### Chart Selection

- 1 Press and hold .
- 2 Select the system setting icon.
- 3 Select Chart then a chart you prefer.

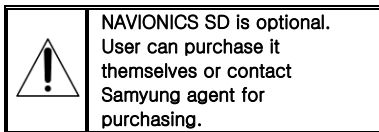

## 2-5 Simulate Mode

Simulate Mode is great for practicing the actual use of a product when the satellites signals and internal alarms are not available. In the simulate mode, the unit turns the GPS receiver off and ignores data from all optional devices..

Two simulate modes are available as below.

- **Normal:** Allows a user to practicing the actual use of a product without satellites connection.
- **Demo:** boat travel alone given route at given speed and show different function of the unit.

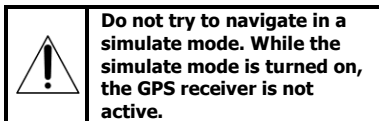

## 2-6 Data Bar

Data bar displays useful navigation information at the top of the display.

35°05.152'N	SOG	0.0	kn	03/Mar/11
129°04.278'E	COG	110	주시각	23:31

### Displaying Data bar

- 1 Press **MENU** and select **Data bar**.
- 2 Select **Data bar**.

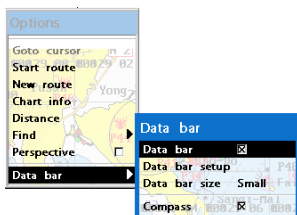

### Setting the data displayed in data bar

- 1 Press **MENU** and select **Data bar**.
- 2 Select **Data bar** then **Data bar setup**.
- 3 Move the cursor key to highlight the data field you want to change then press **↓**.
- 4 Select **Data type**.
- 5 Select a desired data you want to display in the field then press **↓**.
- 6 Repeat above steps if necessary.

### Selecting the Data bar size

- 1 Press **MENU** and select **Data bar**.
- 2 Select **Data bar** then **Data bar size**.
- 3 Select the desired size of data bar.

#### [Large]

E	100	110	120	130	140	150	160	170
35°05.152'N	SOG	0.0	kn					
129°04.277'E	COG			129				

#### [Small]

E	100	110	120	130	140	150
35°05.152'N	SOG	0.0	kn	03/Mar/11		
129°04.278'E	COG	110	주시각	23:31		

**Tip:** If you select None for all data fields, the data bar will disappear to save space for the chart.

**Tip:** Even though you setup a data bar for specific window, the data bar is not apply to all other window.

## 2-7 Compass

The chart plotter computes compass direction from the constellation of GPS satellites. For the GPS chart plotter to compute direction the vessel must be moving through the water..



For easy reading and recognition, there is a compass needle at top right side.

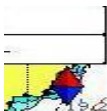

When the compass is displayed, COG is always displayed in data field.

Also when you are navigating to a point, COG and BRG is always displayed in data bar.



**Tip**

COG(Course Over Ground) – The course you vessel is heading.

BRG(Bearing) – The direction from your current position to a destination point.

- To turn the compass off or on:
- 1 Press **MENU** and select **Data bar**.
  - 2 Select **Compass**.

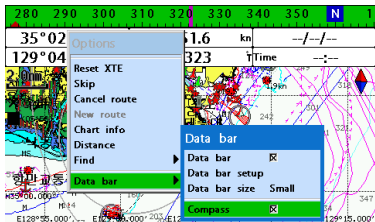

## 2-8 Multi Window Display

The Chart plotter can display up to four windows at the same time.

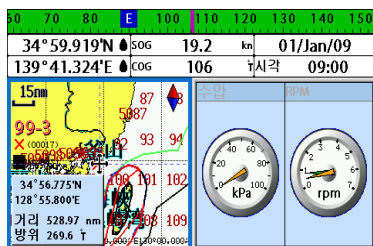

### + Adding a window

- 1 Press **PAGE** and select **Add** icon.
- 2 Select an icon you want to add.
- 3 Repeat above steps if necessary.

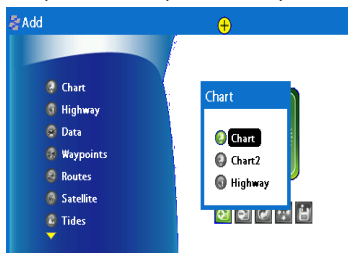

### ↕ Changing window size

- 1 Press **PAGE** and select **Split** icon on bottom.
- 2 Press **▲** or **▼** to change the height of the windows if there is only two windows. If the unit is displaying more than three windows, press **▲**, **▼**, **◀** or **▶** to change the height of the windows.

### ⊖ Deleting a window

- 1 Press and hold **PAGE** to select a window you want to delete.
- 2 Press **PAGE** and select **Remove** icon to remove.

### ↔ Replacing two windows on the display

- 1 Press and hold **PAGE** to active desired window you want to replace.
- 2 Press **PAGE**, select **Replace** icon.
- 3 Select icon you want to display then press **↓**.



## Active Window

To distinguish an active window among windows, an orange border indicates the active window. To change the active window to the next window, press and hold **PAGE**.

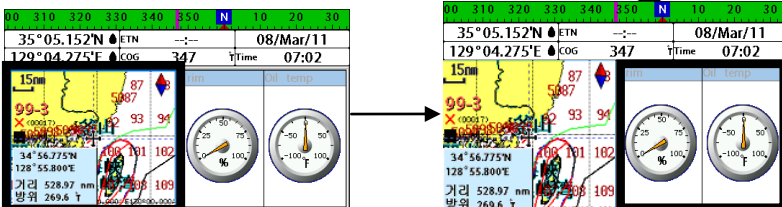

It is important to notice which screen is on due to the multi screens which can be used each screen's function.

## Favorite displays

The most commonly used windows are called favorite displays and up to six favorite windows can be saved. Also each favorite display can have data bar and compass.

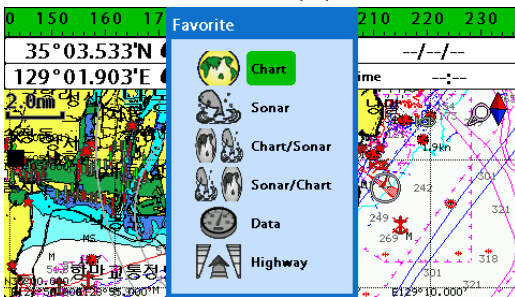

## Displaying a favorite display

- 1 Press **PAGE** twice.
- 2 when above window pops up select a desire display you want.

## Adding a favorite display

- 1 Organize a window as you want.
- 2 Press **PAGE** to show the main window.
- 3 Select **Save** icon at the bottom
- 4 Select an icon where you want to add your favorite display. If you add the new favorite display on existing favorite display new display will overwrite the old display.

## 3 General Operation

### 3-1 Power on and off

#### Manual power on

Press **(D)** and hold until the display shows the start up page. When the Warning screen appears, press **(↓)** to accept.

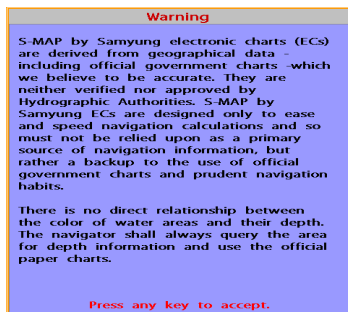

#### Manual power off

Press and hold **(D)** for 5 seconds. A counter timer appears on the screen, if you release the button before the countdown timer reaches zero, the chart plotter will remain On.

### 3-2 Brightness, night mode and Background

You can change the screen setting for the display. To change settings, shortly press **(D)**.

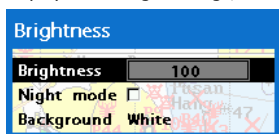

#### Brightness

To change the brightness, select **Brightness**, and press **(←)** to dim or **(→)** to brighten.

Press **(ESC)** to return to the previous screen.

#### Night mode

The chart plotter has preprogrammed settings allowing you to customize the look of the **Chart** window. The default is daytime view. Select **Night mood** depending on what mode the display is in at the time of selection.

To change mode:

- 1 Highlight **Night mode**.
- 2 Press **(→)** or **(↓)**.

**Tip:** The screen will be difficult to read if the chart plotter is in **night mood** when the sun is too bright

#### Background

You can Change the background color if necessary. This selection is a personal preference. Select the option that gives you the clearest viewing in your weather conditions and viewing angle.

### 3-3 The page window

Press **PAGE** to show the page window and select a function icon to display.

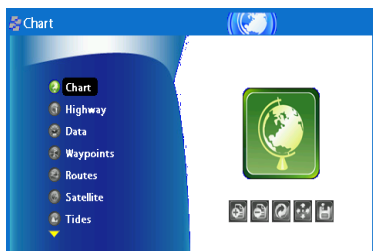

#### Note

- 1 Some function icons require optional units and connected sensors.
- 2 If you press **PAGE** one more time in the main window, favorite window is displayed.



Chart

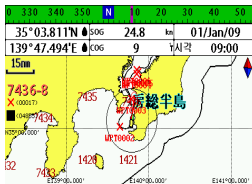

Sonar

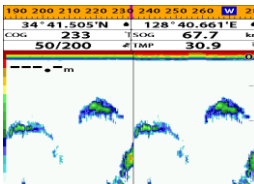

Highway



Data

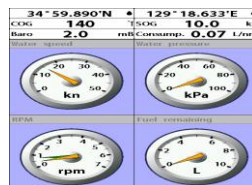

Waypoints

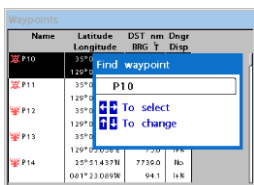

Routes

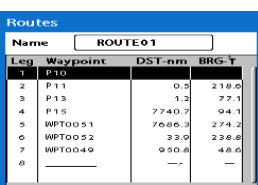

Satellite

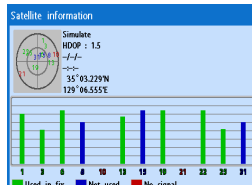

Tides

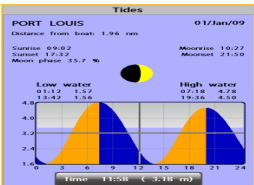

AIS

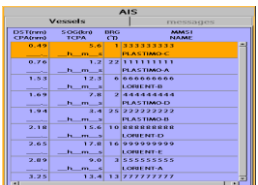

DSC

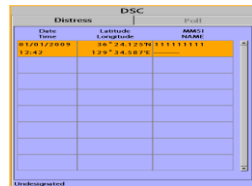

Navtex

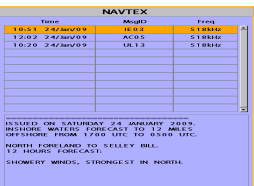

Engine Faults

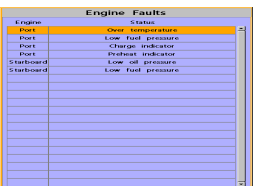



## 3-4 Chart

The **Chart** window mainly shows all relevant navigation data available on your preloaded maps, including buoys, lights, cables, depth soundings, marinas, and tide station in an overhead view.

### 3-4-1 Chart window

To go to the **Chart** window:

- Press **PAGE** and select **Chart** icon by pressing **↓**.

**A typical Chart window shows:**

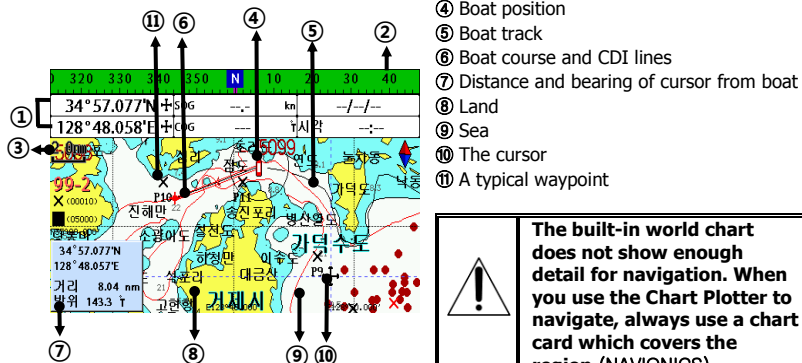

- ① Data bar. To turn the data off or on or to change what data is displayed
- ② Compass
- ③ Chart scale
- ④ Boat position
- ⑤ Boat track
- ⑥ Boat course and CDI lines
- ⑦ Distance and bearing of cursor from boat
- ⑧ Land
- ⑨ Sea
- ⑩ The cursor
- ⑪ A typical waypoint

**The built-in world chart does not show enough detail for navigation. When you use the Chart Plotter to navigate, always use a chart card which covers the region.(NAVICONS)**

### 3-4-2 Latitude and longitude

Latitude and longitude coordinates define a position on earth and can be displayed in data bar.

In the data bar, own ship position is shown as below:

- 47° 43.000' N or S Latitude
- 003° 21.656' E or W Longitude

47° 43.000' N	003° 21.656' W
---------------	----------------

However, if you move the cursor, then the latitude and longitude in the data bar is the cursor's position as below.

- + 47° 43.325' N or S Latitude
- + 003° 29.607' E or W Longitude

47° 43.325' N	003° 20.607' W
---------------	----------------

### 3-4-4 Chart scale

The chart scale change by pressing to show more detail information of chart and by to show wider view of the chart.

When you press or , the scale of chart is display in the chart on top left corner.

### Info

**Latitude:** Angular distance North or South of the equator measured by lines encircling the earth parallel to the equator in degrees from 0° to 90°.

**Longitude:** angular distance North or South of the equator measured by lines encircling the earth parallel to the equator in degrees from 0° to 90°.

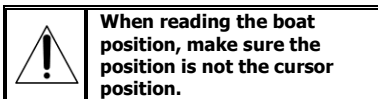

### 3-4-5 Finding a chart symbol

THIS function is only available when NAVIONICS SD card is inserted and NAVIONICS is selected.

#### To find a port by name

- 1 Press .
- 2 Select **Find** then **Port by name**.
- 3 Press or to select a letter then press for next letter.
- 4 Once you enter the name of port, press .
- 5 After searching process, select a nearest port in the list then the cursor will place on the port you selected on the chart window.
- 6 Repeat 2-3 steps of D section to display the information.

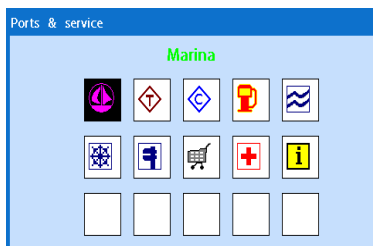
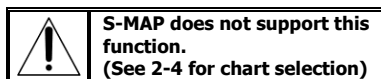

#### To find port & service

- 1 Press .
- 2 Select **Find** then **Port & service**.
- 3 Select a service you want to find.
- 4 After searching process, select a nearest service area in the list then the cursor will place on the service area you selected on the chart window.

### 3-4-6 S-Map search

This function is available when NAVIONICS SD card is inserted and NAVIONICS is selected.

#### To find port & service

- 1 Press **MENU**.
- 2 Select **Find** then **Port**.
- 3 Press **A** or **V** to select a port then **↓**.
- 4 After searching process, select a nearest port in the list then the cursor will place on the port you selected on the chart window.

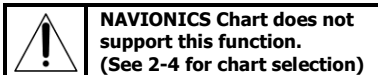

### 3-4-7 Chart symbols and information

This function is only available when NAVIONICS SD card is inserted and NAVIONICS is selected.

Using NAVIONICS Max card allows you to show different kind of symbols and their information on chart plotter display. On some objects such as a port, you can see a picture of landscape layout.

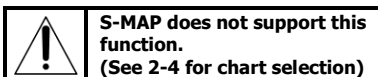

#### To display information

- 1 Move cursor on an icon to display its name.
- 2 Press **MENU** and select **Chart info**.
- 3 Move cursor key to highlight an item and press **↓**.
- 4 Information related to the item appears at the bottom window.

#### [Chart info]

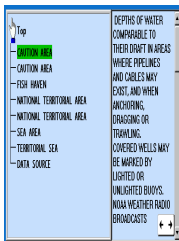

#### [Chart symbol Data Box]

10	150	160	170	S	190	200	210	220	230
35°04.412'N		+	SOG	8.9	km	01/Jan/09			
128°47.662'E		+	COG	188	회시각	09:00			
Lateral beacon									
Light									
Lateral beacon									
Topmark									
Coastline									
Depth contour									
35°04.412'N									
128°47.662'E									
거리 5966.94 nm									
방위 097.2									

### 3-4-8 Introduction to navigating

Use the navigation chart to plan your course, view map information, and as a navigational aid.

This unit has two ways of navigating, going straight to a waypoint or following a route (a group of waypoints).

### 3-4-9 Going to a waypoint or to a point on the chart

A waypoint is a particular location on a voyage whether it is a starting, intermediate or destination point. A waypoint is the simplest piece of information your equipment requires to get you to a destination. In the shortest distance possible. This unit can save up to 10,000 waypoints.

#### Go to Cursor Option

- 1 Press **PAGE** and select the **Chart** window.
- 2 Move the cursor to the destination point.
- 3 Press **MENU** and select **Go to cursor** to start navigating.

#### Goto WPT Option

- 1 Press **PAGE** and select the **Chart** window
- 2 Move the cursor to place cursor on a waypoint.
- 3 Press **MENU** and select **Goto WPT** to start navigating.

### 3-4-10 Following a route

Often a trip from one place to another involves several course changes, requiring a series of route points (waypoints) which you navigate to, one after another. The sequence of waypoints leading to the ultimate destination is called a route. You can save up to 100 routes and a route may consist of 100 waypoints..

#### Start Route Option

- 1 Press **PAGE** and select the chart window.
- 2 Press **MENU** and select **Start Route**.
- 3 Move cursor keys to select a route to start navigating.
- 4 Select **Forward** or **Reverse** to decide which direction you want to navigate.

#### Route Window Option

- 1 Press **PAGE** and select the routes window
- 2 In the route window, mover the cursor to highlight a route you want to start navigating to.
- 3 Press **MENU** and select **start**
- 4 Select **Forward** or **Reverse** to decide which direction you want to navigate.

#### Cancelling navigating

- 1 Press **PAGE** and select the **Chart** icon.
- 2 Press **MENU** and select **Cancel Goto**.

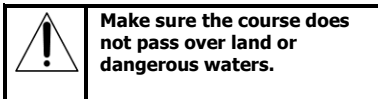

#### Create Route Option

- 1 Press **PAGE** and select the chart window.
- 2 Select **New route**.
- 3 Name a route name.
- 4 Move cursor keys to select a waypoint.  
(Repeat this step as much as you need)
- 5 Press **MENU** and select **Add**.
- 6 Press **ESC**.
- 7 Repeat 2-4 steps of Route window option.

#### Skipping a waypoint

- 1 Press **MENU** and select **Skip**.
- 2 Repeat above step if necessary.

#### Cancelling a route

- 1 Press **PAGE** and select the chart window.
- 2 Press **MENU** and select **Cancel route**.



### 3-4-11 Distance and bearing calculator

The unit can show the bearing and the length of leg and the total distance of legs.

#### Setting Legs

- 1 In the chart window, press **MENU** and select **Distance**. Information is displayed on window showing bearing/leg distance/total distance at bottom pop up at the bottom left side
- 2 Move the cursor to the start point which is start point of first leg and press **↓**.
- 3 Move the cursor to a point which is the end of first leg.
- 4 Repeat 2-3 steps for more legs.
- 5 Press **ESC** to exit.

#### Deleting the last leg

- 1 Press **MENU** and select **Remove**.
- 2 Repeat above step if you want to remove more legs.

### Saving as a route

- 1 Once you set all the legs, press **MENU** and select **Save**.
- 2 Enter a route name by pressing **▲** or **▼** to select a letter then press **▶** for next letter.
- 3 Press **↓** to save the new route.

**Tip:** Bearing and distance

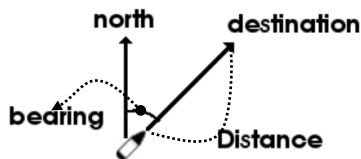

### 3-4-12 Projected course

The projected course shows you how far it can go at give time and speed. This function is very useful to avoid collusion with other vessels.

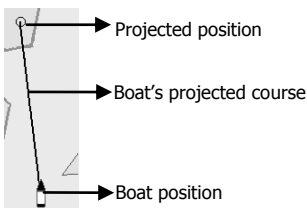

### 3-4-13 Finding a chart symbol

In the chart window, press and hold **↓** then select destination chart symbol.

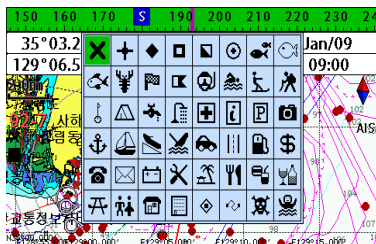

### 3-4-14 Tracks & Log Settings in the chart window

For tracks & log setting in the chart window, press and hold **ESC**. (See 2-4 for Track & Log Settings)

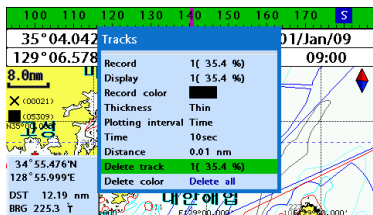



## 3-5 Sonar

It is available to use a sonar function when this equipment is connected to an depth transducer.

Please refer the following process to use Sonar.

- 1 Press **MENU** button longer and set system section.
- 2 Please add the page and select Sonar.
- 3 Press **ESC** button and press **PAGE** button on the main

### 3-5-1 Interpreting the display

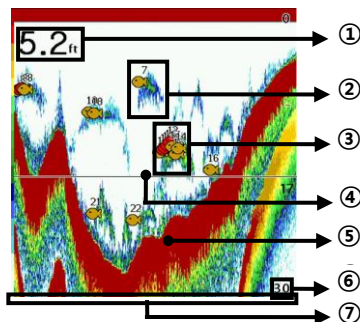

- ① Depth
- ② Single fish : Fish symbols with depth.
- ③ School of fish
- ④ Depth line
- ⑤ Bottom : Hard bottoms such as rock and coral shown as wide bands. Soft bottoms such as mud, weed and sand show as narrow bands.
- ⑥ Range of display
- ⑦ Data from right to left.

### 3-5-2 Mode

There are two options you can select.

- Auto-mode: This is the most commonly used option. In this mode, settings are automatically adjusted for the best display of fish and bottom according to environment.
- Manual Mode: Use this option for manual setting. The option might bring you best result for your purpose.

#### To change a mode:

- 1 Press **MENU** then select Gain.
- 2 Select Mode then choose Manual or Auto mode.
- 3 Press **ESC** to exit until returning to the chart window.

\*NF430 is a 200KHZ only.

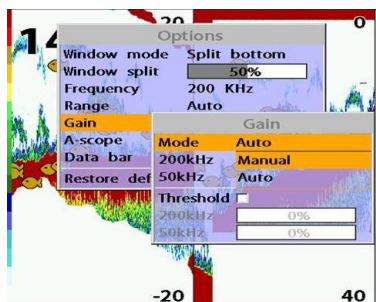

### 3-5-3 Single and Dual frequency fish finding

#### Sonar frequencies

The unit has dual frequency, 200kHz and 50kHz to detect various bottom conditions.

#### To select the sonar frequency in sonar window:

- 1 Press **MENU**, select **Frequency**.
- 2 Select **frequency** and press **↓**.
- 3 Press **ESC** to exit.

#### High frequency (200kHz)

The higher ultrasonic signal, the better is the resolution. For this reason the 200 kHz frequency is ideal for detailed observation of fish schools.

#### Low frequency (50kHz)

The lower frequency signal is, the wider is the detection area. Therefore, the 50kHz frequency is useful for general detection and judging bottom condition.

#### Mixed frequencies (200kHz / 50kHz)

The Mixed frequency combines the 200 kHz and the 50 kHz in the Sonar window. The 50kHz picture appears on the left and the 200kHz picture on the right.

\*NF430 is a 200KHZ only.

### 3-5-4 Range

Range is the depth of water displayed on the sonar window. The basic range may be chosen in Auto or manual mode.

**Auto:** When the mode is set to **Auto**, the unit adjusts the depth automatically for the best performance. This option is recommended for normal operation.

**Manual:** When the mode is set to **Manual**, the unit only displays the depth of water at a given range. That means the sea bottom might not be displayed in the sonar window or it might display half of display in white because range is more important than sea bottom depth. As shown in below images.

The display is useful for comparing the same picture with two different frequencies.

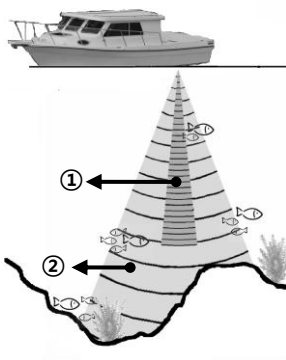

- ① High Frequency (200 kHz)
- ② Low Frequency (50 kHz)

#### To set the manual mode in the sonar window:

- 1 Press **MENU**, select **Range**.
- 2 Select a mode you want and press **↓**.
- 3 If you select the manual mode, press **+** or **-** to change value of max displayed depth.

[When the set depth is too low]

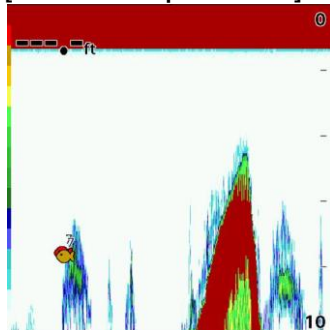

[When the set depth is too high]

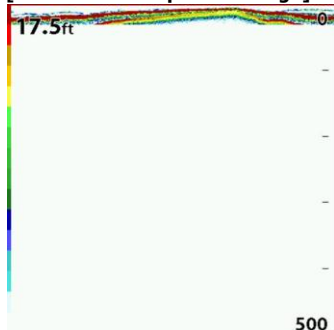

### 3-5-5 Gain

#### The gain menu

The gain is a signal strength received from the transducer and the threshold is the level of ultrasonic that is ignored by a set value. When you use the manual mode and threshold, the values of gain and threshold need to be set very carefully.

In the **Gain** window, you can set for a gain mode and threshold.

Gain	
Mode	Manual
200kHz	10
50kHz	10
Threshold <input type="checkbox"/>	
200kHz	0%
50kHz	0%

#### To change a mode,

- 1 Press **MENU**, select **Gain**.
- 2 Select a mode.
- 3 If you select a **Manual** mode, adjust each frequency gain value by pressing **←** or **→**. Even though you select the **Auto** mode, it will be changed to manual mode if you change the values of frequency.

\*NF430 is a 200KHZ only.

### 3-5-6 Sonar window display

Five sonar display windows are available and each display window has unique characteristics. Select a display window depending on your needs. The default display is No split.

#### To change a Sonar display window in the sonar window:

- 1 Press **MENU**, select Window mode.
- 2 Select the sonar display you want.

**No split:** Display Sonar history at a given frequency (50 or 200 kHz) (see section 3-5-7)

**Split zoom:** This mode expands chosen area of the normal picture in full vertical size on the left-half part of the window.

**Full screen zoom:** Display a zoomed section on full screen (see section 3-5-8)

**Split bottom:** Display Sonar history and a bottom trace focus in a zoomed section (see section 3-5-9)

**Split 50/200:** Display the 50 kHz sonar history on the left and the 200 kHz sonar history on the right. This display is useful for comparing the same history with two different frequencies. (see section 3-5-10)

\*NF430 is a 200KHZ only.

**Split A-Scope:** Display Sonar history and echo strength (see section 3-5-11)

You can change the split ratio if the window is split.

- 1 Press **MENU** and select **Window split**.
- 2 Press **←** or **→** to adjust the ratio.
- 3 Press **↵**.

Options	
Window mode	Split A-scope
Window split	No split
Frequency	Split zoom
Range	Full screen zoom
Gain	Split bottom
Data bar	Split 50/200
Restore default	Split A-scope

### 3-5-7 No split

**No split** window displays a sonar history at a given frequency (50 or 200 kHz)

#### Low Frequency (50 kHz)

The 50 kHz frequency is ideal for detecting the wider area which means low frequency is useful for general detection and judging bottom condition.

#### High Frequency (200 kHz)

The 200 kHz frequency is ideal provide a better resolution which means it is ideal for the observation of fish or fish schools.

To set a frequency for this display:

- 1 Once you select **No split** window, Press **MENU**.
- 2 Select the sonar icon then **Frequency**
- 3 Select a desired frequency

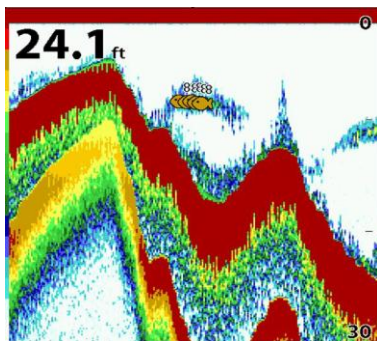

You can also review old sonar records, press **←** and **→** to review the history. To return to current scanning, press **ESC**.

### 3-5-8 Split zoom and Full Screen zoom

#### Split zoom

**Split zoom** mode expands selected area of the single frequency by VRM(Variable Range Mark). The left side displays zoomed section of current sonar record. The VRM of right side indicates the zoom section area.

- Press **▲** or **▼** to change the zoom range.
- Press **+** or **-** to change the depth range.

#### Bottom lock

If **Bottom lock** is on, the zoom depth (the depth of the zoom section) is adjusted automatically so that the bottom is always displayed in the zoom section.

- To turn Bottom lock on or off press **MENU**

#### Full Screen zoom

**Full screen zoom** displays only the zoom section of split zoom.

[Split zoom]

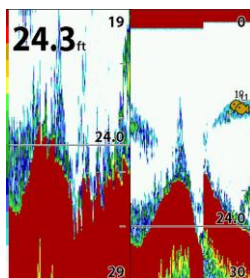

[Bottom Lock]

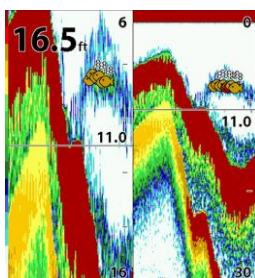

[Full screen zoom]

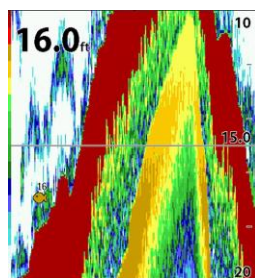

\*NF430 is a 200KHZ only.

### 3-5-9 Split bottom

**Split bottom** display provides a normal picture on the right half and a selectable range over and below the bottom line is expanded onto the left half of the screen. This mode is useful for detecting bottom fishes.

- Use the **◀** or **▶** keys to adjust the zoom range.
- Press **+** or **-** to change the range
- The VRM moves up and down to calculate the bottom depth automatically.

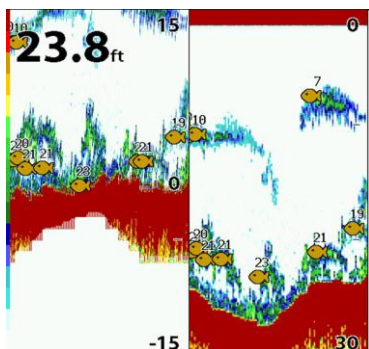

### 3-5-10 Split 50/200

The 50 kHz display appears on the left and the 200 kHz appears on the right. This dual frequency display is very useful for comparing the same scanning with two different frequencies.

\*NF430 is a 200KHZ only.

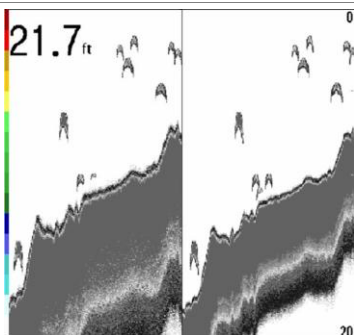

### 3-5-11 Split A-Scope

This display shows echoes at each transmission with amplitudes and colors proportional to their intensities; on the right of the screen it is useful for estimating the kind of fish schools and bottom nature.

Echo strength color code varies from weakest (blue) to strongest (red).

- ① Echoes from fish and the bottom
- ② Unwanted noise echoes.
- ③ The strongest echo, usually from the bottom.

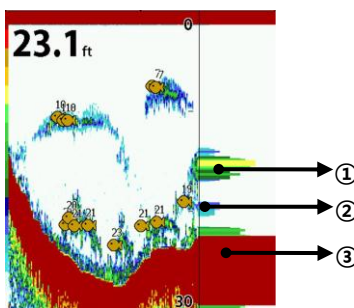





### 3-6 Highway

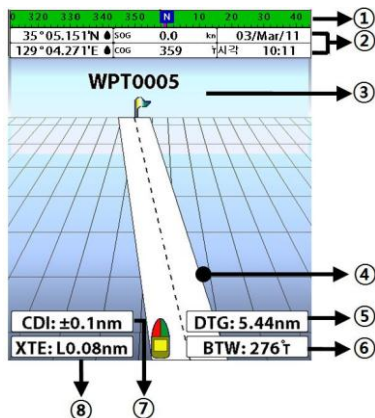

The **Highway** window shows a 3D view of the vessel traveling through the water when navigating to a destination point.

To go to the **Highway** window, press **PAGE** and select **Highway** icon.

The **Highway** window shows:

- ① Compass.
- ② Data bar.
- ③ Destination waypoint.
- ④ Boat's plotted course to destination.
- ⑤ DTG scale (Distance To Go).
- ⑥ BTW scale (Bearing to waypoint).
- ⑦ CDI (Course Deviation Indicator).
- ⑧ XTE scale (Cross Track Error).



### 3-7 Gauges

The **Gauges** window displays all the information you need during navigation such as water, engine, fuel related information, etc.

To select the **Gauges** window, press **PAGE** and select **Data** icon.

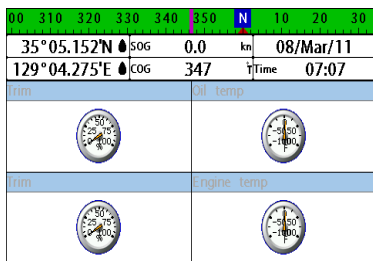

#### Selecting a Gauges layout

The **Gauges** window can show one of seven gauge layouts.

To select a layout from the **Gauges** window:

- 1 Press **MENU** and select **Gauge Layout**.
- 2 Select one layout.

#### Changing a gauge in one selected

To change a gauge displayed in a layout in Data display.

- 1 Press **MENU** and select **Gauge Setup** then the upper left side gauge will be highlighted.
- 2 Select a gauge you want to change and select Gauge type.
- 3 Select a data type you want to display.



## 3-8 Waypoints

A waypoint is a particular location on a voyage whether it is a starting, intermediate or destination point. A waypoint is the simplest piece of information the unit requires to get you to a destination in the shortest distance possible. This unit can save up to 10,000 waypoints.

To display waypoint list, press **PAGE** and select **Waypoint** icon.

Waypoints			
Name	Latitude Longitude	DST nm BRG T	Dngr Disp
P10	35°05.602'N 129°04.672'E	0.6 35.8	No I+N
P11	35°05.195'N 129°04.275'E	0.0 0.8	No I+N
P12	35°05.204'N 129°05.154'E	0.7 85.8	No I+N
P13	35°05.456'N 129°05.658'E	1.2 75.0	No I+N
P14	25°51.437'N 081°23.089'W	7739.0 94.1	No I+N

### 3-8-1 Creating a new waypoint

#### To create a waypoint from the chart window

There are two ways to create a new waypoint from the chart window as described below:

- 1 In the chart screen, press **MENU** and select a new waypoint. (for make a correction then select same as correction)
- 2 Press **PAGE** and select a new waypoint; then press **MENU** and select **Create.** (for make a correction then select same as correction)

### 3-8-2 Moving a waypoint

#### To move a waypoint from the chart window

- 1 Move the cursor to place it on the waypoint you want to move. (If you move the cursor on the waypoint correctly, waypoint information will be displayed at the bottom left).
- 2 Press **MENU** and select **Move.**
- 3 Move the cursor to a point where you want to move and press **↓**.

### 3-8-3 Editing an existing waypoint

#### To Edit a waypoint from the chart window

- 1 Move the cursor to the waypoint you want to edit. (If you move the cursor on the waypoint correctly, waypoint information will be displayed at the bottom left)
- 2 Press **MENU** and select **Edit.**
- 3 Edit waypoint data as you need and press **↓**.

#### To create a waypoint from the waypoints window

- 1 Press **PAGE** to select destination point.
- 2 Press **MENU** and select **Create.**
- 3 Enter waypoint data, change alphanumeric name, choose between 48 icons, 16 colors and display option.
- 4 Select **Save.**

#### To Move a waypoint from the waypoints window

- 1 Highlight a waypoint you want to move.
- 2 Press **MENU** and select **Edit.**
- 3 change the existing latitude and longitude to new position.
- 4 Select **Save.**

#### To Edit a waypoint from the waypoints window

- 1 Move cursor key to highlight a waypoint you want to edit.
- 2 Press **MENU** and select **Edit.**
- 3 Edit waypoint data as you need and press **↓**.

### 3-8-4 Deleting a waypoint

#### To delete a waypoint from the chart window

- 1 Move the cursor to the waypoint you want to delete. (If you move the cursor on the waypoint correctly, waypoint information will be displayed at the bottom left)
- 2 Press **MENU** and select **Delete**.
- 3 Select **Yes**.

#### Deleting a waypoint from the waypoints window

- 1 Move cursor key to highlight a waypoint you want to delete.
- 2 Press **MENU** and select **Delete**.
- 3 Select **Yes**.

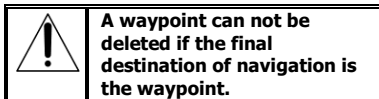

### 3-8-5 Find a waypoint

#### To find a waypoint from the chart window

Finding waypoints from the chart window is a simplified function.

- 1 Press **MENU** and select **Find**.
- 2 Select **Waypoints**.
- 3 Move cursor key to highlight a waypoint you want to find and press **↓**.

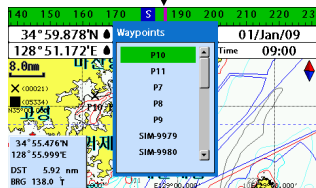
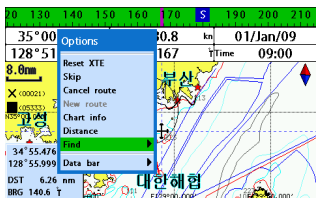

#### To find a waypoint from the waypoint window

Finding waypoints from the waypoint window is provided by a full function.

- 1 Press **MENU** and select **Find**.
- 2 Press **▲**, **▼**, **◀** or **▶** to find a waypoint name.
- 3 Select **↓**.

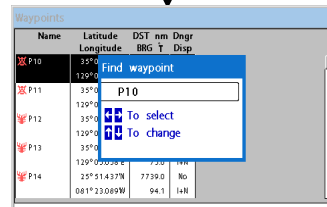
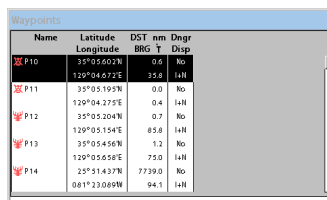

### 3-8-6 Sort Waypoints

To change the order of displayed waypoint list:

- 1 Press **MENU** and select **Sort by**.
- 2 Select a sort type.

### 3-8-7 Deleting all waypoints

- 1 In the waypoints window, press **MENU** and select **Delete all**.
- 2 Select **Yes**.



## 3-9 Routes

A trip from one place to another often involves several course changes, requiring a series of waypoints which you navigate to, one after another. The sequence of waypoints leading to the final destination is called a route. The unit can automatically advance to the next waypoint on a route. So you do not have to change the destination waypoint repeatedly.

The unit has the capability to store 100 routes with maximum of 100 waypoints each.

To display the **Routes** window, press **PAGE** and select the **Routes** window.

Routes		
Name	Start End	Legs DST-nm
ROUTE02	P 2	
ROUTE03	P 2	00.0
ROUTE04	P 2 P 4 P 5	00.0 7808.4
ROUTE05	P 8 P 7	02.3
ROUTE06	P 19 P 19	00.0

### 3-9-1 Managing a route from the chart window

#### Creating a new route window

- 1 Press **MENU** and select **New route**.
- 2 Enter the new route name using cursor key and press **↓**.
- 3 On the **Chart** window, move the cursor to the position of the starting waypoint in the Route and press **←**.
- 4 Move the cursor keys to the position of next waypoint and press **↓**.
- 5 Repeat step 4 to enter more waypoints.
- 6 Once you entered the last waypoint in the route, press **MENU** and select **End**.

#### Editing a waypoint in route while creating a route

- 1 Move the cursor to the waypoint you want to move.
- 2 Press **MENU** and select **Move**.
- 3 Move cursor to a position where you want to move the waypoint and press **↓**.

#### Deleting a last waypoint from the route while creating a route

- 1 Press **MENU** and select **Delete**.

#### Deleting a waypoint from the route while creating a route

- 1 Move the cursor to the waypoint you want to remove.
- 2 Press **MENU** and **Remove**.

**Tip:** Even though you deleted a waypoint in the route, the waypoint still remains in the waypoint list.

#### Inserting a waypoint while creating a route

- 1 If you want to insert a waypoint between waypoints which will be just after the one you want to insert.
- 2 Press **MENU** and select **Insert**.
- 3 Move the cursor to the new inserted waypoint and press **↓**.

#### Inserting a waypoint in front of starting waypoint while creating a route

- 1 Move the cursor to the starting waypoint
- 2 Press **MENU** and select **Insert**.
- 3 Move the cursor to the new start location and press **↓**.

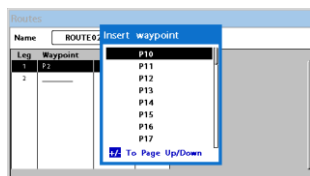

### 3-9-2 Managing a route from the route window

#### Creating a route from the route window

- 1 To go to the **Route** window, press **PAGE** and select the **Route** icon
- 2 Press **MENU** select **Create**
- 3 If you want to enter a route name, highlight name and press **↓**.
- 4 Press **✓** and press **↓**.
- 5 Press **▲** or **▼** to highlight a waypoint
- 6 Press **↓** to insert a waypoint
- 7 Repeat step 5 and 6 until you create a route
- 8 Press **ESC** to exit

#### Inserting a waypoint between two waypoints

- 1 In the **Route** window, select a route you want to insert in the route list and press **↓** or press **PAGE** and select **Edit**.
- 2 Highlight a leg where you want to insert a waypoint
- 3 Press **MENU** and select insert
- 4 Highlight a waypoint and press **↓**.
- 5 Press **ESC** to exit

#### Editing a route in the chart window

- 1 In the route list, press **MENU** and select **Edit** on chart.
- 2 Follow the procedure of "Editing a waypoint in route while creating a route "

#### Deleting a waypoint in the waypoint list

- 1 Highlight a waypoint you want to delete in the waypoint list.
- 2 Press **MENU** and select **Remove**.

#### Deleting a route in the route window

- 1 Highlight a route you want to delete.
- 2 Press **MENU** and select **Delete**.

#### Deleting all route in the route window

- 1 Press **MENU** and select **Delete All**.

Displaying a route in the **Chart** window from the route list:

- 1 Highlight a route you want to display in the **Chart** window.
- 2 Press **MENU** and select **Display**.

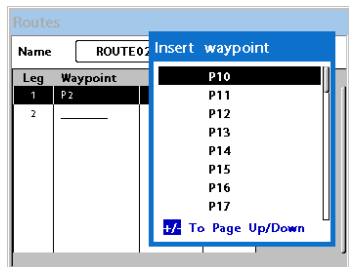



## 3-10 Satellites

### 3-10-1 Satellite information

#### Acquiring GPS signals

When the unit is first turned on it will take some time for the GPS signal acquiring. After signals are received, the unit will automatically find a position of boat in the chart window.

#### Satellite information window

The satellite window displays different information about the GPS satellites and GPS position as below.

To go to the satellite window, press **PAGE** and select **Satellite** icon.

The satellite window shows:

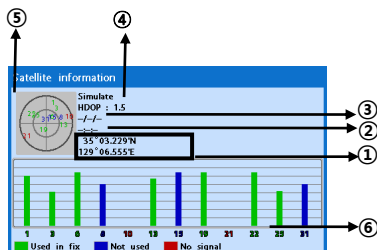

- ① Ship's Coordinates.
- ② Time received GPS satellites.
- ③ Date received GPS satellites.
- ④ HDOP: Horizontal Dilution of Precision. It is a parameter indicating the accuracy of the GPS.
- ⑤ Location of GPS Satellites.
- ⑥ GPS signal strengths status in graph.

Press **↓** to display GPS signal information from GPS satellite in NMEA0183 data format at the GPS signal strengths status display. To return to GPS signal strengths status display, press **↓** again.

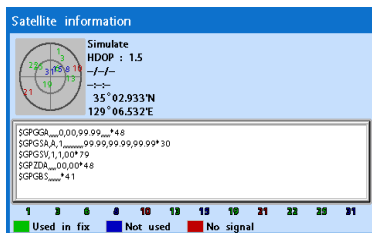



## 3-11 Tides

The **Tides** window is useful for boaters that are concerned about the height of the water or by fisherman that wish to know the tide and moon phase of a specific date.

### Displaying a tide information from the chart window

- 1 In the **Chart** window, press **MENU**.
- 2 Select **Find and Tide station**.
- 3 Press **▲** or **▼** to move cursor and select a tide station
- 4 Press **▲**, **▼**, **◀** or **▶** to the position of selected tide station and press **↓**.
- 5 Select **Tide height station** to display the information
- 6 Press **ESC** to exit.

### Displaying tide station information in the tides window

- 1 Press **PAGE** and select **Tides** window.
- 2 Select **Tide height station** to display the information.
- 3 Press **ESC** to exit.

**Tip:** The unit only displays the tide information nearest your boat in the tides windows.

### Choosing the date of the tide information.

- 1 In the Tides window, Press **MENU** and select one of the following options.
  - **Set date:** manually set a date.
  - **Today:** automatically set the date of today.
  - **Next day:** automatically set the date of today.
  - **Prev day:** automatically set the date of yesterday
- 2 Press **ESC** to return to the window

### The tides window shows data for the chosen date

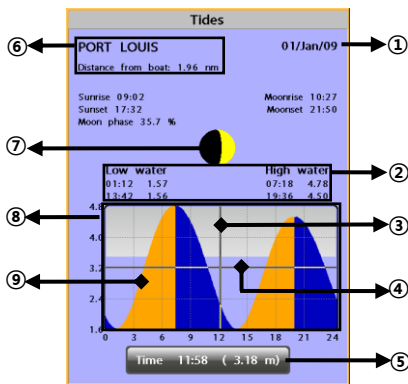

- ① Current time and chosen date for display.
- ② Data for the chosen date.
- ③ Tide height cursor, a horizontal dotted line. Press **▲** or **▼** to move cursor up and down.
- ④ Time cursor, a vertical dotted line. Press **◀** or **▶** to move cursor sideways.
- ⑤ Time of cursor and tide height at that time.
- ⑥ Tide station name and distance from boat.
- ⑦ Moon phase for moon at the current time on the chosen date.
- ⑧ Tide chart.
- ⑨ Tide height.

In case of SAMYUNG MAP is already set, it (Please refer to 2-4 how to select a map)

## 3-12 AIS

AIS is an Automatic Identification System for identification and localization of boat. AIS provide a means for boats to exchange and share boat data including identification, position, course, etc. This information can be displayed on the screen of you unit. AIS is intended to assist you to monitor other boats movements to improve safety and prevent collision.

AIS functions require an optional AIS unit to be installed.

To activate AIS function:

- 1 Press and hold **MENU** and select **System Configuration** icon..
2. Press **ESC** and press display from the top page and select AIS.

### 3-11-1 Viewing AIS Vessels

When the unit is connected to AIS unit which support NMEA0183 or NMEA2000, you can check other vessel that are equipped with AIS unit on the screen. To check AIS information place the cursor on the AIS object then AIS information displays at the bottom of window.

- ① AIS equipped vessel
- ② Dangerous Vessel
- ③ Projected Course
- ④ AIS equipped vessel Data Box
- ⑤ Range Rings

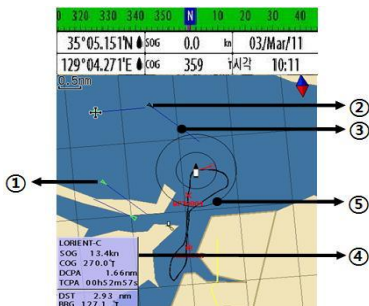

### 3-12-2 AIS Windows

To display the AIS windows:

- 1 Press display, and select **AIS** icon.
- 2 Press and hold display to select one of the two tabs: **Vessels** or **Messages** tab.
  - **Vessel:** show you all the AIS equipped vessel around you. (up to 200 vessels)
  - **Message:** show you all the messages related to safety from other AIS equipped vessels.

**Caution** : The display can show information for 250 vessels as maximum.

#### Sorting Vessels

- 1 Press **MENU**, select **Sort by**.
- 2 Select one of the options

#### Displaying an AIS vessel on the chart

To overlay AIS equipped vessel on the chart window:

- 1 Press **▲** or **▼** to select a vessel you want to display in **AIS** window.
- 2 Press **MENU** and select **Display**

#### Displaying AIS equipped vessel Details

- 1 Press **▲** or **▼** to select a vessel you want to display full AIS detail in the **AIS** window.
- 2 Press **↓** or press **MENU** and select **More Info**.
- 3 Press **◀** or **▶** to see more detail.





## 3-13 DSC

This feature requires connection to optional DSC VHF radio.

DSC window shows the distress and poll information received from other vessel through DSC VHF radio.

- 1 Press and Hold Menu, then select the system configuration.
- 2 Select the optional components and select DSC
- 3 Press ESC and press DISPLAY from the top page then select DSC.

### 3-13-1 1 distress

During a distress situation, a vessel that is equipped with a DSC VHF radio and connected to GPS has the capability to transmit a DSC distress call with GPS position. When a compatible VHF radio receives a distress call, the distress call location is displayed on the screen and it is logged into **DSC Distress** window.

Date Time		Latitude Longitude	MMSI Name

#### Displaying a distressed vessel in the chart window

- 1 Highlight a received distress call you want to display.
- 2 Press **MENU** and select **Display**.

#### Going to the distress position

- 1 Highlight a received distress call you want to navigate to.
- 2 Press **MENU** and select **Goto**.

#### Editing a distress waypoint

- 1 Highlight a received distress call you want to edit.
- 2 Press **MENU** and select **Edit Waypoint**.
- 3 Change data field and select **Save**.

**Tip:** When receiving a Distress call from other vessel, it creates a distress waypoint automatically. However, the waypoint you edit in option menu is a different waypoint from the distress waypoint

#### Deleting a Distress Call

- 1 Highlight a received distress call you want to delete.
- 2 Press **MENU** and select **Delete**.

#### Deleting all Distress Call

- 1 Press **MENU** and select **Delete all**.

**Tip:** Even though you delete a DSC call, the DSC waypoints still exist.

#### Distress Message

When the distress message is received, the distress message will be popped up as below

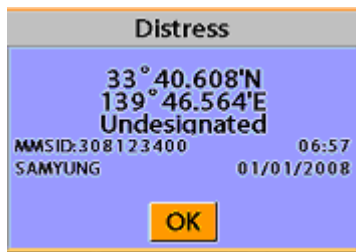

### 3-13-2 Poll

#### Poll

A compatible radio with the unit can request the position of other DSC VHF radio equipped vessels around its position. When the position of a vessel is received, the location is displayed on the screen and it is logged into Poll window

To display the **Poll** tab, press and hold **PAGE**.

#### Displaying an poll vessel in the chart window

- 1 Highlight a poll you want to display.
- 2 Press **MENU** and select **Display**.

#### Going to the poll vessel position

- 1 Highlight a poll you want to go.
- 2 Press **MENU** and select **Goto**.

#### Edit a distress waypoint

- 1 Highlight a poll you want to edit.
- 2 Press **MENU** and select **Edit Waypoint**.
- 3 Change data field and select **Save**

 **Tip:** When receiving a poll from other vessel, it does not create a waypoint as a distress call

#### Deleting a poll

- 1 Highlight a received distress call you want to delete.
- 2 Press **MENU** and select **Delete**.

#### Deleting all poll

- 1 Press **MENU** and select **Delete all**.

 **Tip:** Even though you delete a DSC call, the DSC waypoints still exist.

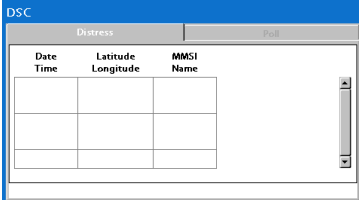

Date Time	Latitude Longitude	MMSI Name



## 4 Settings

The system menu mainly consists of settings which do not require frequent adjustment. To go to system menu, press and hold **MENU** then select the icon you want.

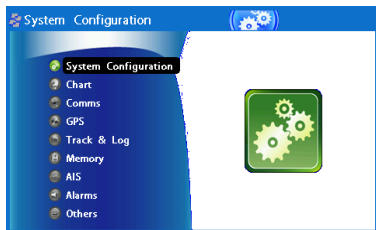

- ① System Configuration.
- ② Chart.
- ③ Communication.
- ④ GPS.
- ⑤ Track & Log.
- ⑥ Memory.
- ⑦ AIS.
- ⑧ Alarms.
- ⑨ Others.



### 4-1 System Configuration Settings

To go to **System configuration**:

- 1 Press and hold **MENU**.
- 2 Select the **system configuration** icon.

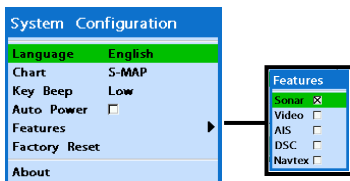

#### 4-1-1 Language

Change the language for menus and data screens.

#### 4-1-2 Chart Selection

Select a chart between S-MAP or NAVIONICS chart.

#### 4-1-3 Beep volume

Select the level of beep sound.

#### 4-1-4 Auto power

See section 3-1.

#### 4-1-5 Features

When external devices are connected to the unit, the corresponding options need to be set.

#### 4-1-6 Factory reset

When this option is selected. All settings of this unit returns to default factory settings.

#### 4-1-7 Unit information

The unit information window shows:

- 1 Software version and release date.
- 2 NAVIONICS version.
- 3 Stored waypoints, routes and tracks count
- 4 Wiring information of connector.

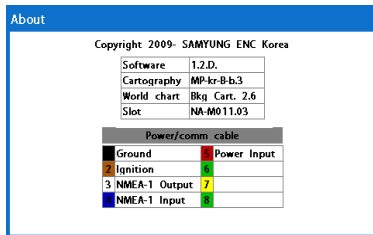



## 4-2 Chart Settings

To go to the chart settings:

- 1 Press and hold **MENU**.
- 2 Select the chart icon.

The screenshot displays the chart settings interface, which is divided into several sections:

- Chart**:
  - Rotation: North up
  - Palette: Sunlight
  - General
  - Land & Sea
  - Map Datum: WGS84
  - NMEA datum offset: OFF
  - Map shift: OFF
  - Restore default
- Plotter mode**:
  - Plotter mode:
  - Mixing levels:
  - AntiClutter:
  - Value added data:
  - Lat/Lon grid:
  - Boundaries: Auto
  - Text/Icon Size: Small
  - Names:
  - Nav-aids & Light Sector: On
  - Nav-aids: INT
  - Attention areas:
  - Projected course: 30 min
  - CDI scale: 0.1 nm
- Land & Sea**:
  - Water features:
  - Object depths:
  - Spot soundings:
  - Sounding min: 0 ft
  - Sounding max: 10 ft
  - Tidal stream:
  - Land features:
  - Land elevation:
  - Security navigation zone:
    - Enabled:
    - Value: 10 ft
- S-MAP**:
  - Lat/Lon grid:
  - Depth Digit:
  - Lighthouse:
  - Buoy:
  - Wreck Ship:
  - Fish Haven:
  - Sea Lane:
  - Restricted Area:
  - Fishing Area:
  - Sea Cable:
  - Name:
  - Mark Attribute:
  - Projected course: 30 min
  - CDI scale: 0.1 nm
- Land & Sea** (Secondary):
  - Land: 6
  - Mud: 4
  - Rocky: 5
  - 5 m: 13
  - 10 m: 12
  - Sea
  - 20 m: 3
  - 30 m: 9
  - 50 m: 13
  - 100 m: 12
  - 200 m: 6
  - 300 m ~: 7

#### 4-2-1 Rotation

Three types of display presentations are provided. The default is heading up.

**North up:** North is at the top of the display.

**Heading up:** When course is set, the course is at the top of screen all the times.

**Course up:** When destination is set it is at the top of the screen. This option is only available when you are navigating to a destination.

#### 4-2- Palette

Palettes are used to enhance the visibility of the display depending on the surrounding light environments. Four types of displays are provided; Normal, NOAA, Sunlight and Night.

#### 4-2-3-1 General (NAVIONICS)

**Plotter mode:** this mode allows you to zoom in and out at scales where cartographic data are not available.

**Mixing levels:** when the map coverage at the current chart scale does not fill the entire display, the GPS chart plotter draws the rest of map using charts from above and below the current scale. When this function is turned on you will notice the display may redraw 2 to 3 times to show all the detail.

**Nav-aids:** The way to display fog, radar and radio station signals. (International and US)

**Attention areas:** Turns the displaying of Attention Areas where need to pay attention more) On or Off.

**Projected course:** Display the Projected course in given set time.

**CDI scale:** Set CDI (Course Deviation Indicator) scale which is a parallel line on either side of the plotted course.

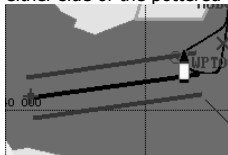

**AntiClutter:** when this option is selected, less important information (names & icons) are hidden when they are overlapped.

**Value added data:** The Value Added Data(VAD) is a collection of additional cartographic objects which are not present on the original paper chart.

These objects have been obtained from other sources and then merged to the electronic charts in order to provide more information useful for the navigation.

**Lat/Lon Grid:** Turns the displaying of the latitude and longitude grid lines on or off on the chart window.

**Boundaries:** Turns the displaying of chart boundaries on, off or auto mode which shows the chart boundaries of the two charts below the current scale.

**Text/Icon Size:** change the size of text and icon on the chart.

**Names:** Display area names in the chart.

**Nav-aids & Light Sector:** Turns the presentation of Light, Signals, Buoys and Beacons On, Off, No Sector (Nav-Aids are shown, Light Sectors are hidden) or Animated (The lights are flashed).

#### 4-2-3-2 General(S-MAP)

**Lat/Lon grid:** Turns the displaying of Lat/Lon on or off

**Depth Digit:** Turns the displaying of water depth on or off

**Lighthouse:** Turns the displaying of Lighthouse on or off

**Buoy:** Turns the displaying of buoys on or off

**Wreck Ship:** Turns the displaying of Wreck Ship on or off

**Fish Haven:** Turns the displaying of Fish Haven on or off

**Sea Lane:** Turns the displaying of Sea Lane on or off

**Restricted Area:** Turns the displaying of Restricted area on or off

**Fishing Area:** Turns the displaying of Fishing Area on or off

**Sea Cable:** Turns the displaying of Sea Cable on or off

**Name:** Turns the displaying of area name on or off

**Mark Attribute:** Turns the displaying of Mark Attribute on or off

**Sea Sector No:** Turns the displaying of Sea Sector No on or off

#### 4-2-4-1 Land & Sea (NAVIONICS)

**Water features:** Turns the displaying of sea bed nature and tide stations icon on or off.

**Object depths:** Turns the displaying of object depths on or off.

**Spot soundings:** Turns the displaying of spot sounding on or off.

**Sounding min:** Set the minimum depth limit to show depth sounding, bathymetric lines and depth area.

**Sounding max:** Set the maximum depth limit to show depth sounding, bathymetric lines and depth area.

**Tidal stream:** Turns the displaying of tidal streams on or off.

**Land Features:** Turns the displaying of land features on or off.

**Land elevation:** Turns the displaying of land elevations on or off.

**Safe Navigation Area:** Set the water depth for safe navigation and displaying safe navigation area in color.

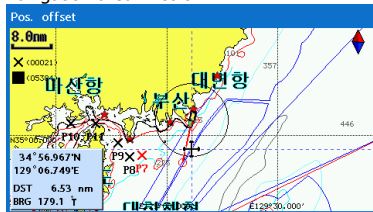

#### 4-2-4-2 Land & Sea (S-MAP)

Turns the displaying of sea color in 16 different colors.

#### 4-2-5 Map datum

This unit has a compatibility with most of major chart system and this option allows you to select a map datum. The default datum is WGS84.

Map datum Selection

- 1 Press and hold **MENU** and select chart icon
- 2 Select general and Map datum
- 3 Select a desired map datum

#### 4-2-6 NMEA datum offset

When you select other Map datum different from WGS84, latitude and longitude will be different from WGS84'S coordinates and this might confuse other device such as VHF radio if connected to the unit. If this option is applied, latitude and longitude send on the unit NMEA output will be the same as coordinates in WGS84.

#### 4-2-7 Map shift

Sometimes current position of own ship does not match with the current location on the chart. To correct this position error, you can apply a map shift.

##### Applying a map shift

- 1 In the Chart setup menu, press and hold **MENU** and select **Chart** icon.
- 2 Select Map shift to **ON**.
- 3 Move cursor to the actual position on the chart.
- 4 Press **MENU** and select **Set**.

##### Canceling a map shift

If you want to clear the map shift:

- 1 In the Chart setup menu, select **Map shift**.
- 2 Press **MENU** and select **Clear**.

#### 4-2-8 Restore default

Returns every chat settings to default.





## 4-3 GPS Settings

To go to the GPS settings:

- 1 Press and hold **MENU**.
- 2 Select the **GPS** icon.

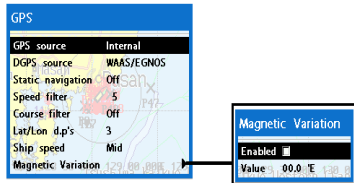

When the GPS device is connected properly, the GPS settings provide the access to GPS functions and features connected with the satellites information used for further navigation

### 4-3-1 GPS Source

Select a source of GPS signals

**Internal:** Select this option when uses the internal GPS antenna.

**NMEA0183 & NMEA2000:** Select this option when using an external GPS or DGPS antenna via NMEA.

### 4-3-2 DGPS Source

Select WAAS/EGNOS when you want to utilize DGPS.

### 4-3-3 Static Navigation

This option is very useful when the boat stops or moves very slowly. This option allows you to set a minimum speed at which movement is assumed. The value range is from 0.00 to 9.99.

### 4-3-4 Speed Filter

Occasional waves and wind at sea affect the boat speed. In order to have stable boat speed, the unit calculates these factors to give the value of stable speed information.

### 4-3-5 Course Filter

Occasional waves and wind at sea affect the boat course. In order to have stable boat course, the unit calculates these factors to give the value of stable course information.

### 4-3-6 Lat/Lon d.p's

Select number of last digit of Lat/Lon to be sent to other marine electronics.

### 4-3-7 Ship speed

To have more precise boat speed and course, you can select your boat speed. Mid is highly recommended option for the most of common boat.

### 4-3-8 Magnetic Variation

This option compensates the difference between true north and magnetic north.

## 4-4 Track & Log Settings

To go to the tracking and long settings:

- 1 Press and hold **MENU**.
- 2 Select the **track & log** icon.

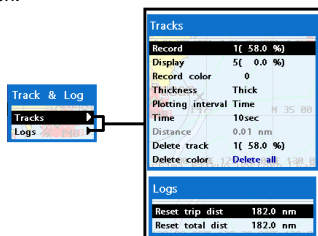

The unit has the capability to store 10 individual tracks and record up to 15,000 track points. Before using the track function you will need to setup the track function that suits your boat.

### 4-4-1 Track

#### Record

**Off:** Stop a recording of Track 1 to 10 (select a track number): Start a recording of the boat's course.

#### Display

**Off:** Display no track on the chart.  
1 to 5 (select a track number): Display a selected track on the chart.

#### Record color

Select the color of recording track.

#### Thickness

Select the thickness of recorded track.

#### Plotting Interval

Select the method of plotting interval between time and distance.

#### Distance

Select the distance of plotting interval.

#### Time

Select the time of plotting interval.

#### Delete track

Delete a selected track record.

### 4-4-2 Log

#### Reset trip dist

Shows you the trip distance. If you select this option it resets the trip distance.

#### Reset total dist

Show you the total trip distance. If you select this option it resets the total trip distance.



## 4-5 Memory Settings

To go to the memory settings:

- 1 Press and hold **MENU**.
- 2 Select the **Memory** icon.

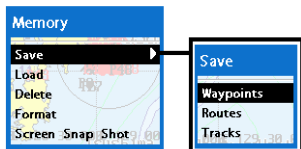

A user card is an option SD card which you need to purchase additionally. Before you use a user card it must be formatted. Note that formatting a user card erases all saved data.

### 4-5-1 Save

Select a data type you want to save in the user card then the data will be saved in the user card automatically.

- 1 If you select waypoint for saving data, enter the file name and press .
- 2 If you select routes for saving data, enter the file name and press .
- 3 If you select tracks for saving data, enter the file name and press .

#### [Waypoint]

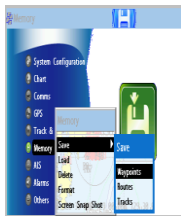

#### [Track]

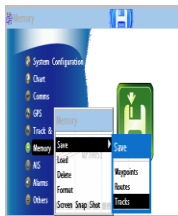

### 4-5-2 Load

Select a data you want to load into the load list then press .

Load					
Name	Type	Time			
Slot1 Device not present					
Wpts	50	Tr.3	0	Tr.7	0
Route	10	Tr.4	0	Tr.8	0
Tr.1	8743	Tr.5	0	Tr.9	0
Tr.2	0	Tr.6	0	Tr.10	0

### 4-5-3 Delete

Select a data you want to delete then press .

Also, you can sort the file by name. Press **MENU** and select **sort by name**.

Delete					
Name	Type	Time			
Slot1 Device not present					
Wpts	50	Tr.3	0	Tr.7	0
Route	10	Tr.4	0	Tr.8	0
Tr.1	8744	Tr.5	0	Tr.9	0
Tr.2	0	Tr.6	0	Tr.10	0

#### 4-5-4 Format

Erase all data in the user card. Format the user card before using it.

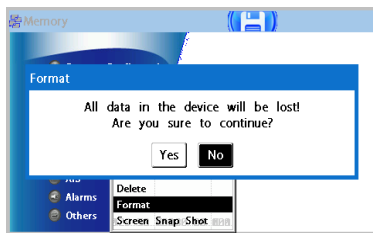

#### 4-5-5 Screen Snap Shot

To take the snap shot of current screen, press **Ⓢ** twice. To save the captured image, press **MENU** and select **Save** or **Save all** to save the captured images on the user card.

Screen Snap Shot		
Name	Size	Time
110803A	383KB	07:56 08/Mar/09
110803B	383KB	07:57 08/Mar/09
110803C	383KB	07:57 08/Mar/09
110803D	383KB	07:57 08/Mar/09
110803E	383KB	07:58 08/Mar/09

#### 4-6 AIS Settings

##### Note

AIS feature require an optional AIS receiver.

To go to the AIS settings:

- 1 Press and hold **MENU**.
- 2 Select the AIS Icon.

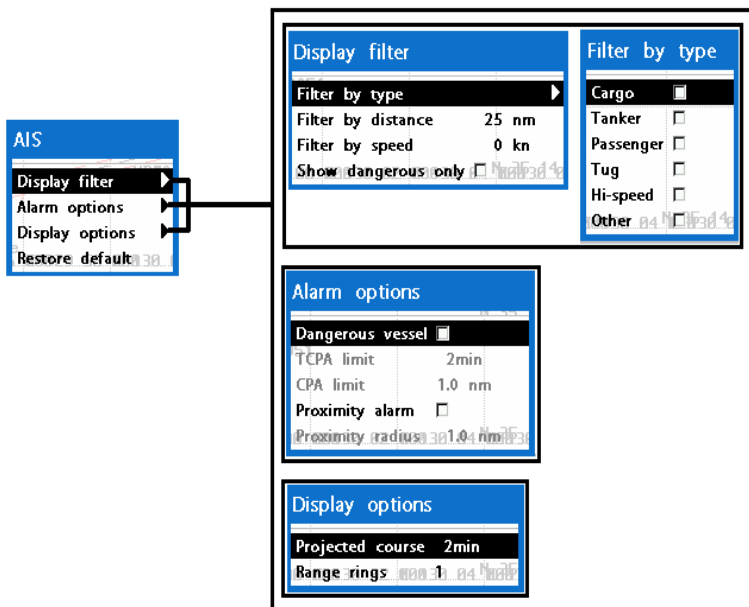

#### 4-6-1 Display Filter

There are a couple of methods to filter AIS vessel in this unit as below.

**Filter by Type** : The type of vessel which is selected will not be displayed on the chart.

**Filter by distance** : Vessels outside the radius of selected distance from own ship is filtered.

#### 4-6-2 Alarm Option

**Dangerous Vessel Alarm** : When this option is selected an alarm will activate. Even this option is not selected; dangerous vessels will still be on the chart.

**TCPA Limit** : Set the Time of Closet Point of Approach limit.

**CPA Limit** : Set the Closet Point of Approach limit.

**Proximity alarm** : Trigger an alarm when any AIS equipped vessel is within a set proximity radius.

**Proximity radius** : Set a radius for proximity alarm.

**Filter by speed** : Vessels with speed below the set value are filtered.

**Show Dangerous Only** : When this option is selected, it shows dangerous vessel only.

#### 4-6-3 Display Option

**Projected course** : Set a time for projected course. The project course show the estimate course of vessel base on the given time.

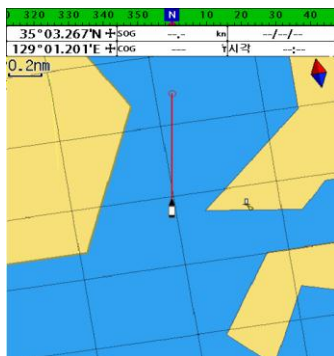

**Range rings** : Select a number of Range rings.

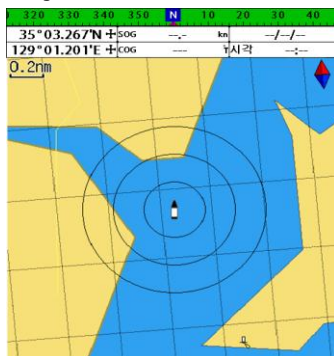

#### 4-6-4 Restore Default

Returns every AIS setting to default..



## 4-7 Alarm Settings

Press long **MENU** then select **Alarms**:

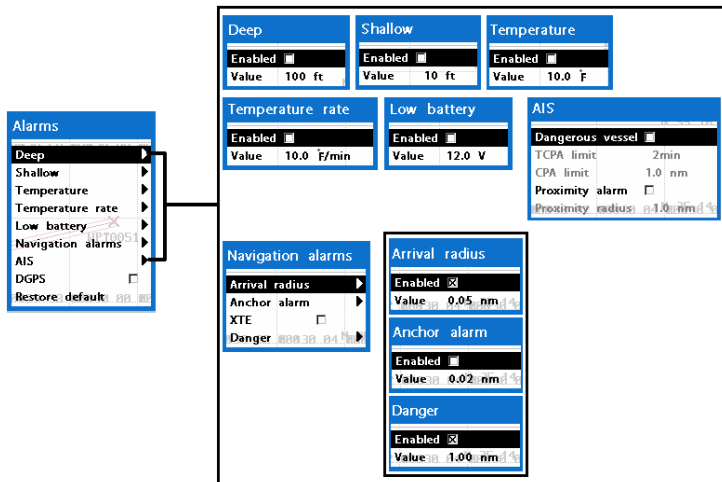

A warning message with beep sound is displayed when an alarm condition is met by user setting. Press **ESC** to clear the alarm. However, the alarm will be displayed again when the alarm condition occurs again. The unit provides alarms for various functions.

### 4-7-1 Deep

Trigger an alarm when the depth value received from the transducer is deeper than a set value.

### 4-7-2 Shallow

Trigger an alarm when the depth value received from the transducer is shallower than a set value.

### 4-7-3 Temperature

Trigger an alarm when the reported temperature from the transducer is same as a set value.

### 4-7-4 Temperature rate

Trigger an alarm when the rate of temperature change from the transducer is same as a set value.

### 4-7-5 Low battery

Trigger an alarm when battery voltage is lower than a set value.

### 4-7-6 Navigation alarms

**Arrival radius** : Trigger an alarm when your boat is approaching the destination to set value

**Anchor alarm** : Trigger an alarm when your boat moves more than set valve

**XTE** : Trigger an alarm when your boat moves off the current CDI scale.

**Danger** : Trigger an alarm when your boat is getting closed to dangerous point.

### 4-7-7 AIS

See the Alarm option of 4-7 (AIS Settings).

### 4-7-8 DGPS

Trigger an alarm when DGPS signal is not received.

### 4-7-9 Restore default

Returns every alarm settings to default.



## 4-8 Others

Press long **MENU** then select **Others**:

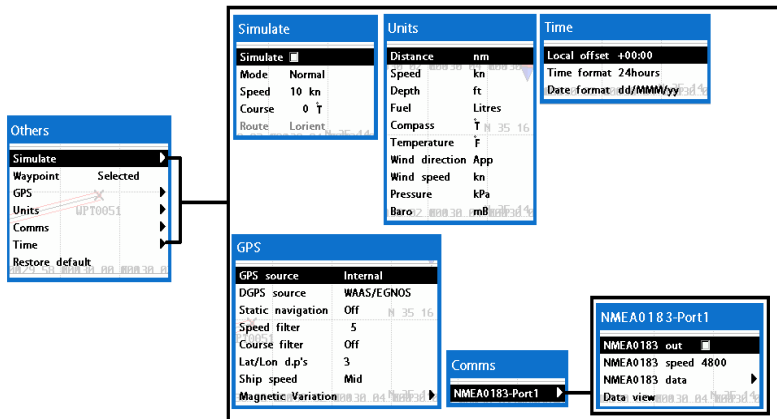

### 4-8-1 Simulate

**Simulate** : Turn the simulate mode on or off.

**Mode** : See 2-4 Simulate Mode.

**Speed** : The simulated boat speed to use.

**Course** : The simulated course over ground.

**Route** : The route to follow.

### 4-8-2 Waypoint

Select a way to display waypoints.

### 4-8-3 GPS

See 4-4 GPS Settings.

### 4-8-4 Units

Select a unit of each measure.

**Tip**: Requires a optional VHF receiver with barometer connected: InHg or mB.

### 4-8-5 Comms.

Use this feature when the unit is connected to other marine electronics through any compatible NMEA instrument.

**NMEA0183/NMEA2000**: This option to transmit NMEA sentences to other marine electronics. NMEA0183 and NMEA2000 interfaces are generally used with third party marine electronics. Select a port (NMEA2000, NMEA0183-Port 1 or NMEA0183-Port 2), a communication speed and select a desired output data.

### 4-8-6 Time

**Local offset** : The time information supplied by the GPS satellites is in UTC (Universal Time Coordinates). To read the correct time, change the time of GPS chart plotter for daylight saving time start and end.

**Time format** : Select the format of time.

**Date format** : Select the format of date.

### 4-8-7 Restore default

Returns every other setting to default

## 5 INSTALLATION

Correct installation is important to the performance of the unit. It is vital to read the entire installation section of this manual and the documentation that comes with the antenna and any other units before starting installation. For further information, please contact Samyung ENC.

### 5-1 Options and Accessories

#### Optional sensors and instruments

- GPS or DGPS Antenna

- DSC VHF Radio

- Other instruments: The chart plotter can receive data from other instruments and send data to other instruments by NMEA..

#### Connections

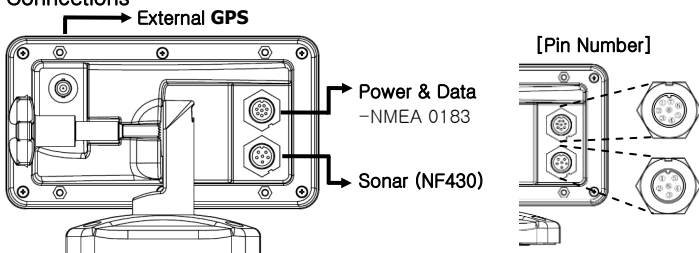

#### [Power & Data]

Pin Number	Colour	Functions
1	Black	Ground: - Power in, NMEA ground
2		No use
3	White	NMEA 1 Out
4	Green	NMEA 1 In
5	Red	+ power in, 10 to 35 V DC
6		No use
7		No use
8		No use

#### [Sonar]

Pin Number	Functions
1	Sonar +
2	Temp, GND
3	Not Use
4	Temp
5	Sonar -
6	Sonar - GND



## 5-2 Connections

The GPS chart plotter has connectors that are used to connect to the power supply, GPS antenna and to NMEA devices such as VHF's AIS receivers, digital instruments and autopilots.

## 5-3 Power / Data Cable

### Power

- Connect each equipment as the below picture for Power.

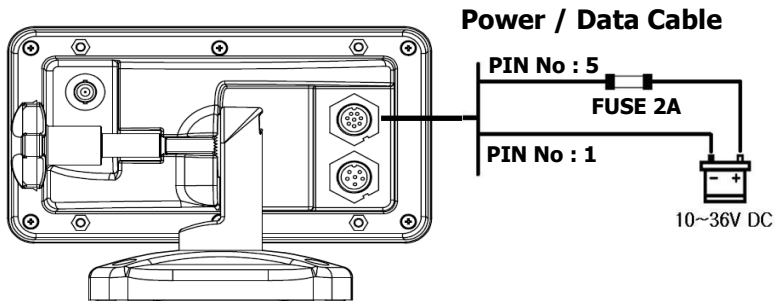

## 5-4 GPS Antenna

### 5-4-1 External Antenna

It is available to connect to an external GPS Antenna with BNC type of Connector.

#### Install an External Antenna

If an external antenna is required, install the antenna and fit the antenna cable back to the display unit. Follow the instructions in the manual supplied with the antenna. Fit an optional extension cable if required.

During setup, configure the data for the chosen antenna.

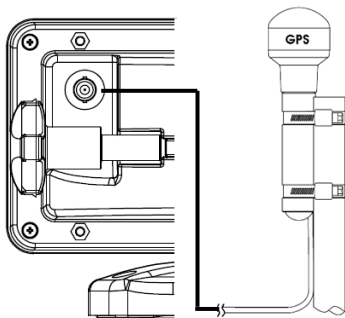

## 5-4-2 The Antenna by using NMEA

### Antenna by using NMEA

The chart plotter can receive the GPS data from the compatible device (NMEA). The chart plotter can connect several devices to an external GPS.

- An optional differential beacon DGPS antenna to give enhanced accuracy within range of land based differential beacons in areas where WAAS or EGNOS are not available. Such a DGPS antenna has both a GPS receiver and a beacon receiver, and it automatically applies the beacon correction to the GPS position.

### To set the DGPS options(Non or WAAS/EGNOS):

Connect the GPS directly to the input. Set the option. The new setting will be displayed if it was successfully applied.

### Note:

The chart plotter can apply the WAAS and EGNOS DGPS corrections to any GPS antenna.

For more information, contact Samyung ENC.

## 5-5 Sonar

### Sonar

- Connect each equipment as the below picture for Sonar power.

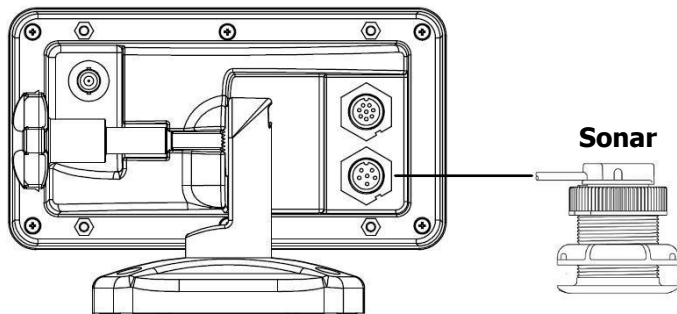

## 5-6 NMEA 0183

This GPS chart plotter can be connected to external devices with NMEA0183 and display information such as followings.

DSC VHF Radio

- GPS antenna(NMEA 0183)
- Navtex
- AIS receiver

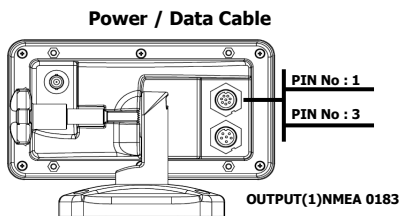
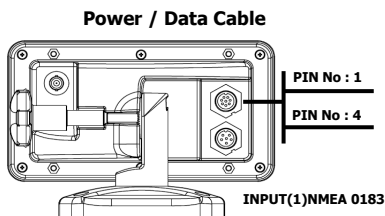

### DSC VHF radio

Fit and set up the optional DSC VHF radio as above Pictures: NMEA 0183(1) IN and NMEA 0183(2) IN.

### Other NMEA instruments

NMEA is an industry standard for interconnecting instruments. The chart plotter can be connected to other NMEA instruments. Set up the optional NMEA instruments as above pictures.

- The chart plotter can receive and display depth, paddlewheel boat speed and water temperature from an optional compatible instrument.
- The chart plotter can receive data from an optional compatible GPS or GPS/DGPS source.

- The chart plotter can send GPS position and other navigation data to an autopilot or other instrument. An autopilot requires APB, APA and VTG sentences
- For information on sending NMEA data to the instrument, contact Samyung ENC.

During setup to send NMEA data to other instruments, set NMEA out and specify the NMEA data to send.

## 5-7 Setup and Test

- 1 Put a blanking cap on any unused connector on the back of the display unit. Ensure all connectors are plugged in and the display unit is in place.
- 2 If the display unit is bracket mounted, adjust tilt and rotation for best viewing and hand tighten the knob.
- 3 Insert any required NAVIONICS chart card.
- 4 Enter setup data to set up the chart plotter to your requirements and to set up any optional sensors or instruments.
- 5 At the satellite display, check that it picks up GPS satellites. Wait for the GPS receiver to start up and the GPS satellite to change to 'Used in fix'.

 **SAMYUNG ENC** 1 YEAR WARRANTY

Thank you for purchasing an SAMYUNG ENC product. This product has been thoroughly checked and is covered by the **Samyung ENC's warranty** for defects in materials and workmanship under normal use from the date of purchase.

This warranty provides for the free repair or replacement of defective parts from our Samyung ENC authorized dealer.

In the event that your SAMYUNG ENC product needs service, please return your SAMYUNG ENC product at your expense (shipping and insurance) to your Samyung ENC distributor or SAMYUNG ENC authorized Service Centres. SAMYUNG ENC will, at its discretion, repair or replace any defective products or its components at no cost to you. This is your exclusive remedy for defective products

**Followings are not under Warranty .**

1. Consumable items, including, but not limited to: fuses, impellers, impeller bearings, impeller shafts are specifically excluded from this warranty
2. All costs associated with transducer replacement, other than the cost of the transducer itself
3. As a result of incorrect installation, misuse, accident, water damage, abuse or other external causes
4. By modification or service other than by SAMYUNG ENC or authorized distributors, authorized Service Centres
5. If the serial number label on the unit has been removed, altered or mutilated







**SAMYUNG ENC**

[www.samyungenc.com](http://www.samyungenc.com)

 **SAMYUNG ENC Co.,Ltd.**

Head Office : 1123-17, Dongsam-Dong, Youngdo-Gu, Busan, Korea, 606-083 Tel : 82-51-601-5530(Rep.) Fax : 82-51-413-4446  
A/S Center : 65-20, 2-Ga Namhang-Dong, Yungdo-Gu, Busan, Korea, 606-032 Tel : 82-51-601-5570-4(Rep.) Fax : 82-51-416-5515