

+

Safety instructions



This device's electronic chart system (ECS) is developed for the navigational aid only and chart itself does not obtain any approvals; has not been certified from the government authorities.

If operator needs safe navigation then must use an official chart that has been approved by government agencies;

also operator is fully responsible for using this device.

Please read through this manual before the first operation. If you have any questions, please contact the customer service or your local dealer or distributor

Extensive exposure to heat may result in damage to the chart plotter.

Connection to the power source with reversed polarity will damage the chart plotter severely. This damage is not covered by the warranty.

Do not disassemble. The chart plotter contains dangerous high voltage circuits which only experienced technicians must handle

Exposure of the display to UV rays may shorten the life of the liquid crystals used in you plotter. This limitation is due to the current technology of the LCD display.



Avoid overheating which may cause loss of contrast and, in extreme case, a darkening of the screen. Problems which occur from over heating are reversible when temperature decreases.











Screen Cleaning Precautions

Cleaning your chart plotter screen is a very important operation and must be done carefully. The following is the cleaning procedure.



You use a tissue or lens tissue and a cleaning spray containing Isopropanol (a normal spray cleaner sold for PC screens. Fold the tissue or lens tissue into a triangular shape, moisten the tip and use the index finger behind a corner to move the tissue across the surface, in overlapping side to side strokes. If the tissue is too wet, a noticeable wet film will be left in its path and you will need to repeat the process. If too dry, the tissue won't glide easily, and may damage the surface.







If you require technical advice or assistance, contact your nearest samyung enc office or visit our website, www.samyungenc.com.

| | |
|---|-----------|
| 1 Introduction | 9 |
| 1-1 General Information | 9 |
| 1-2 Specification..... | 10 |
| 1-3 Components | 12 |
| 1-4 Optional Component | 12 |
| 2 Getting Started | 13 |
| 2-1 Installation..... | 13 |
| 2-1-1 Bracket Mounting | 13 |
| 2-2 Buttons | 14 |
| 2-3 NAVIONICS SD Card, USB..... | 17 |
| 2-4 Chart Selection | 17 |
| 2-5 Simulation | 18 |
| 2-6 Data Bar | 18 |
| 2-7 Compass | 19 |
| 2-8 Multi Window Display | 20 |
| 2-9 User Line Drawing..... | 22 |
| 3 General Operation..... | 23 |
| 3-1 Power on and off | 23 |
| 3-2 Brightness, night mode and Background | 23 |
| 3-3 Main window | 24 |
|  3-4 Chart | 26 |
| 3-4-1 Chart Window..... | 26 |
| 3-4-2 Latitude and Longitude..... | 27 |
| 3-4-3 Chart scale | 27 |
| 3-4-4 NAVIONICS Search | 27 |
| 3-4-5 SAMYUNG Map Search | 28 |
| 3-4-6 Symbols and information | 28 |
| 3-4-7 Introduction to navigating..... | 28 |
| 3-4-8 Going to a waypoint or to a point on the chart..... | 29 |
| 3-4-9 Following a route | 29 |
| 3-4-10 Distance and bearing calculator | 30 |
| 3-4-11 Projected course | 30 |
| 3-4-12 Finding a chart symbol..... | 30 |
| 3-4-13 Setting Tracks in the chart window | 31 |
| 3-4-14 3D MAP | 32 |
|  3-5 VIDEO | 32 |
| 3-5-1 Option | 33 |
|  3-6 Sonar | 34 |
| 3-6-1 Display Description..... | 34 |
| 3-6-2 Mode..... | 34 |
| 3-6-3 Single or Dual Frequency Fish finding..... | 35 |
| 3-6-4 Range..... | 35 |
| 3-6-5 Gain | 36 |
| 3-6-6 Sonar window display..... | 37 |
| 3-6-7 No plit | 37 |
| 3-6-8 Split zoom and Full Screen zoom | 38 |
| 3-6-9 Split bottom | 38 |

| | | |
|---|---|-----------|
| | 3-6-10 Split 50/200 | 39 |
| | 3-6-11 Split A-Scope | 39 |
|  | 3-7 Highway | 40 |
|  | 3-8 Data | 40 |
|  | 3-9 Waypoints | 41 |
| | 3-9-1 Creating a new waypoint | 41 |
| | 3-9-2 Moving a waypoint | 41 |
| | 3-9-3 Editing an existing waypoint | 41 |
| | 3-9-4 Deleting a waypoint | 42 |
| | 3-9-5 Find a waypoint | 42 |
| | 3-9-6 Sort Waypoints | 43 |
| | 3-9-7 Deleting all waypoints | 43 |
|  | 3-10 Routes | 44 |
| | 3-10-1 Managing a route from the chart window | 44 |
| | 3-10-2 Managing a route from the route window | 45 |
|  | 3-11 Satellites..... | 46 |
| | 3-11-1 Satellite Information | 46 |
|  | 3-12 Tides | 47 |
|  | 3-13 AIS..... | 48 |
| | 3-13-1 Viewing AIS Vessels | 48 |
| | 3-13-2 AIS Windows..... | 48 |
|  | 3-14 DSC..... | 50 |
| | 3-14-1 Distress | 50 |
| | 3-14-2 Poll | 51 |
|  | 3-15 Navtex..... | 52 |
|  | 3-16 Engine Faults..... | 52 |

4 Settings..... 53

| | | |
|---|--|-----------|
|  | 4-1 System Configuration Settings | 53 |
| | 4-1-1 Language..... | 53 |
| | 4-1-2 Chart Selection | 53 |
| | 4-1-3 Beep volume | 53 |
| | 4-1-4 Auto power | 53 |
| | 4-1-5 Features | 53 |
| | 4-1-6 Factory reset | 53 |
| | 4-1-7 Unit information | 53 |
|  | 4-2 Chart settings | 54 |
| | 4-2-1 Rotation..... | 55 |
| | 4-2-2 Palette..... | 55 |
| | 4-2-3-1 General(NAVIONICS)..... | 55 |
| | 4-2-3-2 Land & Sea (S-MAP) | 55 |
| | 4-2-4-1 Land & Sea (NAVIONICS)..... | 55 |
| | 4-2-5 Map datum | 56 |
| | 4-2-6 NMEA datum offset..... | 56 |
| | 4-2-7 Map shift | 56 |

| | | |
|---|---|-----------|
| | 4-2-7 Map shift | 56 |
| | 4-2-8 Restore default..... | 56 |
|  | 4-3 Sonar settings | 57 |
| | 4-3-1 Frequency | 57 |
| | 4-3-2 Palette | 57 |
| | 4-3-3 Scroll speed | 57 |
| | 4-3-4 Digit size | 57 |
| | 4-3-5 Fish | 57 |
| | 4-3-6 Advance Settings | 57 |
| | 4-3-7 Restore default | 57 |
|  | 4-4 GPS Settings..... | 58 |
| | 4-4-1 GPS Source | 58 |
| | 4-4-2 DGPS Source | 58 |
| | 4-4-3 Static Navigation..... | 58 |
| | 4-4-4 Speed Filter | 58 |
| | 4-4-5 Course Filter | 58 |
| | 4-4-6 Lat/Lon d.p's | 58 |
| | 4-4-7 Ship speed | 58 |
| | 4-4-8 Magnetic Variation | 58 |
|  | 4-5 Track & Log Settings | 59 |
| | 4-5-1 Track..... | 59 |
| | 4-5-2 Log..... | 59 |
|  | 4-6 Memory Settings | 60 |
| | 4-6-1 Save | 60 |
| | 4-6-2 Load | 60 |
| | 4-6-3 Delete..... | 60 |
| | 4-6-4 Format..... | 61 |
| | 4-6-5 Screen Snap Shot | 61 |
|  | 4-7 AIS Settings..... | 61 |
| | 4-7-1 Display Filter | 62 |
| | 4-7-2 Alarm Option | 62 |
| | 4-7-3 Display Option | 62 |
| | 4-7-4 Restore Default..... | 62 |
|  | 4-8 Alarm Settings..... | 63 |
| | 4-8-1 Deep | 63 |
| | 4-8-2 Shallow | 63 |
| | 4-8-3 Temperature | 63 |
| | 4-8-4 Temperature rate..... | 63 |
| | 4-8-5 Low battery | 63 |
| | 4-8-6 Navigation alarms | 63 |
| | 4-8-7 AIS..... | 63 |
| | 4-8-8 DGPS..... | 63 |
| | 4-8-9 Restore default | 63 |
|  | 4-9 Other settings | 64 |
| | 4-9-1 Simulate | 65 |
| | 4-9-2 Waypoint | 65 |
| | 4-9-3 GPS | 65 |
| | 4-9-4 Vedio | 65 |
| | 4-9-5 Units..... | 65 |

| | |
|-----------------------------|----|
| 4-9-6 Comms | 65 |
| 4-9-7 Time..... | 65 |
| 4-9-8 GNB..... | 65 |
| 4-9-9 Restore default | 65 |

5 CONNECTIONS.....66

| | |
|---|-----------|
| 5-1 OPTIONAL PART | 66 |
| 5-2 CONNECTION | 69 |
| 5-3 Power supply & DATA cable..... | 69 |
| 5-4 Alert equipment | 69 |
| 5-5 GPS ANTENNA | 70 |
| 5-5-1 External antenna | 70 |
| 5-5-2 Internal antenna | 70 |
| 5-6 NMEA 0183 | 70 |
| 5-7 DATA..... | 71 |
| 5-7-1 DGPS/NMEA ANTENNA | 72 |
| 5-7-2 NMEA2000 | 72 |
| 5-8 MEDIA | 73 |
| 5-9 Set up and Test | 73 |

1 Introduction

1-1 General Information

The chart plotter is a precision-crafted GPS chart Plotter with high-performance receiver for the Global Positioning System constellation of satellites, providing precise location data with a host of navigation features. Some functions require optional units and sensors installed on your boat. The chart plotter can be connected to external devices with NMEA0183 and NMEA2000 interface and display information. Following are the examples.

- NAVTEX
- VIDEO
- AIS RECEIVER
- DSC VHF RADIO
- Transducer & sensors
- Autopilot

1-2 Specification

[NF100]

| GENERAL | |
|--|--|
| Category | Detail |
| Size | 235mm(H) x 349mm(W) x 90mm(D) |
| Display | 10.4 inch, TFT color, 800X600 pixel |
| Supply Voltage | 11 ~ 36 V DC |
| Supply Current | 24V (Equipment Only) Maximum LCD Brightness 1A Minimum LCD Brightness 700mA |
| Alarm Output | Sound alarm equipment, 30V DC, maximum 200mA |
| Temperature | -10°C ~ +50°C |
| ALARMS | |
| User setting: Alarm alert, anchor alert, XTE, danger alert, low battery, AIS dangerous vessel alert, AIS approach alert. | |
| GPS NAVIGATION | |
| Chart card | SD card |
| User card | SD card |
| Waypoints | Up to 30,000 |
| Routes | 100 routes (1route – 100points) |
| Tracks | 10 tracks setting (1 track–30000 points) |
| Chart datums | 216 chart datums |
| Chart scale | approximately 0.2 ~ 500 nm (1/2,500 ~ 1/37,500,000) |
| COMMUNICATIONS | |
| NMEA | NMEA 0183 Speed : 4800, 9600, 38400 , NMEA 2000 |
| NMEA 0183 input | DBK, DBS, DBT, DPT, GGA, GLL, GNS, GGA, GSV, HDG, HDT, MDA, MTA, MTW, MWD, MWV, RMC, RPM, VHW, VTG, VWT, ZDA |
| NMEA 2000 input | System date and time(PGN126992),Vessel Heading(PGN127250),Engine parameters/Rapid Update(PGN127488),Engine parameters/Dynamic(PGN127489),Trip parameters/Engine(PGN127497),Engine parameters/Static(PGN127498),Fluid level(PGN127505),Water Speed(PGN128259),Water depth(PGN128267),Position/Rapid Update(PGN129025),COG & SOG/Rapid Update(PGN129026),GNSS Position Data(PGN129029),GNSS DOPs(PGN129539),GNSS Sats in View(PGN129540),Wind Data(PGN130306),Environmental Parameter–Water temp(PGN130310),Environmental Parameter(PGN130311) |
| NMEA 0183 output | APA, APB, BWR, GGA, GLL, GSA, GSV, RMB, RMC, VTG, XTE, DBT, DPT, MTW, VHW, XDR |
| NMEA 2000 output | +++Water Speed(128259), Water depth(128267), XTE(129283), NAV. data(129284), NAV. data(129285), COG & SOG(129026), GNSS position(129029), Water temp.(130310) |
| FISHFINDER * measurable water level may vary due to the weather condition. | |
| Depth *Possible depth | 0m ~ 600m (600W) / 0m ~1000m (1KW) |
| Output of transducer | Power : it is variable and maximum 1KW RMS Can use 2 frequency (50 kHz, 200 kHz) |
| Temperature | Range : 0° ~ 37.7°C (32°F ~ 99.9°F) |

[N100]

| General | |
|--|--|
| Category | Detail |
| Size | 235mm(H) x 349mm(W) x 90mm(D) |
| Display | 10.4 inch. TFT color, 800X600 pixel |
| Supply Voltage | 11 ~ 36 V DC |
| Supply current | 24V (Equipment only) Maximum LCD Brightness 750mA Minimum LCD Brightness 500mA |
| Alarm output | Sound alarm equipment, 30V DC, maximum 200mA |
| Temperature | -10°C ~ +50°C |
| ALARM | |
| User setting: Alarm alert, anchor alert, XTE, danger alert, low battery, AIS dangerous vessel alert, AIS approach alert. | |
| GPS NAVIGATION | |
| Chart card | SD Card |
| User card | SD Card |
| Waypoints | Up to 30,000 |
| Routes | 100 routes (1 route – 100 points) |
| Tracks | 10 Tracks (1 track-30,000 points) |
| Chart datums | 216 chart datums |
| Chart scale | approximately 0.2 ~ 500 nm (1/2,500 ~ 1/37,500,000) |
| COMMUNICATIONS | |
| NMEA | NMEA 0183 Speed : 4800, 9600, 38400 , NMEA 2000 |
| NMEA 0183 Input | DBK, DBS, DBT, DPT, GGA, GLL, GNS, GGA, GSV, HDG, HDT, MDA, MTA, MTW, MWD, MWV, RMC, RPM, VHW, VTG, VWT, ZDA |
| NMEA 2000 Input | System date and time(PGN126992),Vessel Heading(PGN127250),Engine parameters/Rapid Update(PGN127488),Engine parameters/Dynamic(PGN127489),Trip parameters/Engine(PGN127497),Engine parameters/Static(PGN127498),Fluid level(PGN127505),Water Speed(PGN128259),Water depth(PGN128267),Position/Rapid Update(PGN129025),COG & SOG/Rapid Update(PGN129026),GNSS Position Data(PGN129029),GNSS DOPs(PGN129539),GNSS Sats in View(PGN129540),Wind Data(PGN130306),Environmental Parameter-Water temp(PGN130310),Environmental Parameter(PGN130311) |
| NMEA 0183 Output | APA, APB, BWR, GGA, GLL, GSA, GSV, RMB, RMC, VTG, XTE, DBT, DPT, MTW, VHW, XDR |
| NMEA 2000 Output | +++Water Speed(128259), Water depth(128267), XTE(129283), NAV. data(129284), NAV. data(129285), COG & SOG(129026), GNSS position(129029), Water temp.(130310) |

1-3 Components

| List | Part Number | |
|------------------------|-------------------|--------|
| | NF100 | N100 |
| Display | NF100-K | N100-K |
| Bracket | N100-DB | |
| Cover | N100-CC | |
| Power cable | SYCB006C2C-P-N100 | |
| Bracket mounting screw | N100-BP | |
| Built in kit screw | N100-TK | |
| Protection Cover | N100-CB | |
| User Manual | N100-MK | |
| GPS Antenna | SAN-60-10m | |
| Quick user guide(ENG) | N100-QSG | |
| 50/200KHZ Transducer | B45 | X |

1-4 Optional Component

| Model | Part Number | List |
|-------------------------------------|--------------|--|
| GPS Antenna+ GPS Antenna support | SAN-60-20m | GPS Antenna+ BNC Plug |
| | | GPS Antenna support |
| | | GPS Antenna cable(20m) |
| GPS Antenna stand support | 57745 | GPS Antenna stand support |
| Remote control | REM-3D-K | Optional |
| Remote control cable | REM-3D-A | Optional |
| Y cable | N100-YC | DGPS, NMEA2000connection converter |
| MEDIA cable | N-MEDIA-C | S-VIDEO, AUDIO, CCTV connection converter |
| 50/200KHZ transducer | speed P58 | Optional |

2 Getting Started

2-1 Installation

The chart plotter is supplied with bracket and flush mounting kit. You can choose a method of installation according to your preference.

2-1-1 Bracket Mounting

Find the appropriate place to install considering GPS Chart plotter's weight and user convenience.

Mounting the display unit:

- 1 Hold the display unit and place the screw between the display and the knob.
- 2 Gently push and turn the bracket mounting screw to the display unit

Removing the display unit

- 1 Turn the unit off
- 2 Turn the bracket mounting knob gently to remove.

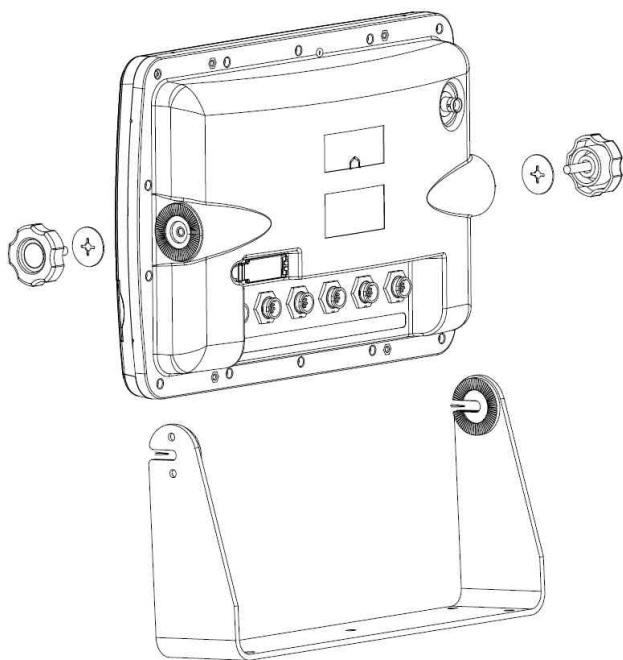

2-2 Buttons

[FRONT]

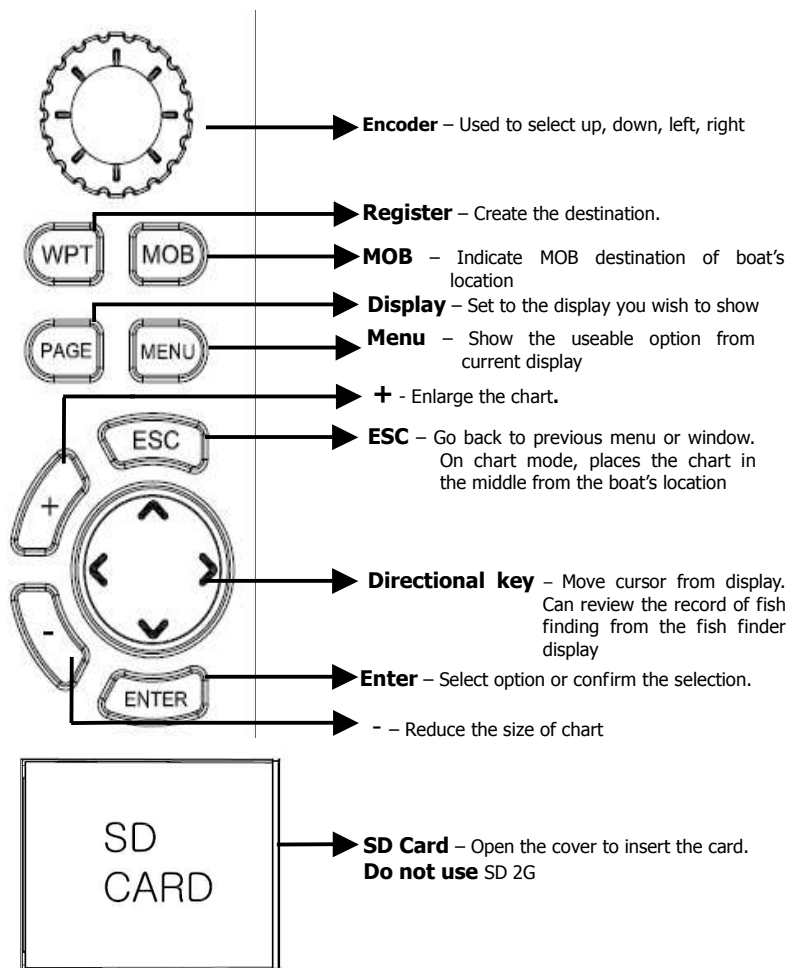

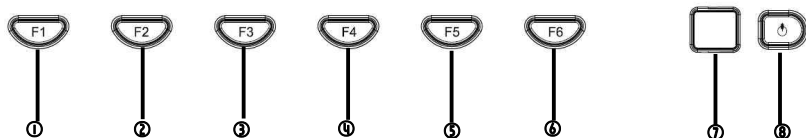

- ① Press F1 once goes to Plotter → press it consecutively and will show Plotter and low frequency → press again and will show plotter and high frequency → press again and will show plotter and dual frequency → press again for low frequency → high frequency → dual frequency then it will go back to Plotter
- ② Under multi display, when you press it, it goes to multi display menu, and enables you to adjust the display. Under Sonar, when you press it, the noise menu pops up.
- ③ The electronic buoy menu appears on the bottom of the screen.
- ④ You may set the track.
- ⑤ The menu appears on the bottom for you to choose. You may use the plotter as navigational use or fishing. You may use this button to adjust the incline, enlarge depth, and grid.
- ⑥ The music folder appears, and when you press menu, it will let you to open the files from USB or SD card and play the music.
- ⑦ Face the REM-3D remote control to this box and press the button of remote control.
- ⑧ Power on/off. Adjust the brightness of night mode. Save the current page

[REM-350]

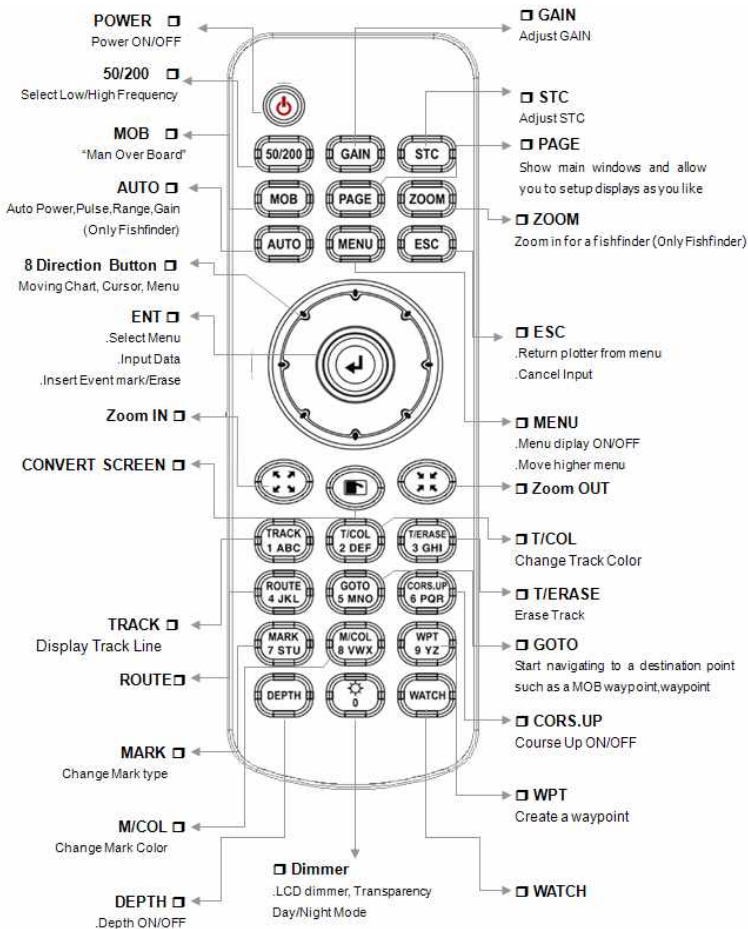

2-3 NAVIONICS SD Card, USB

This section explains how to insert and remove the NAVIONICS SD Card and USB.

Inserting SD Card

- 1 You have two slots for SD card as shown in ①, when you insert to the left slot, face the label to left as shown in ③ and for right slot, face the label to the right as shown in ④
- 2 Open the cover and insert SD card to the slot. Insert it until you hear click, then close the cover.

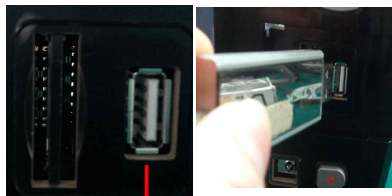

SD Card Slot USB Slot

Removing SD Card

- 1 Turn the equipment off
- 2 Open the cover and press SD card to remove.
- 3 Close the cover.

Inserting USB

- 1 Refer to ②, check the terminal carefully and insert the usb..

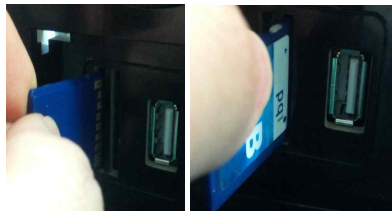

③ ④

Removing USB

- 1 Hold the USB and pull it out.

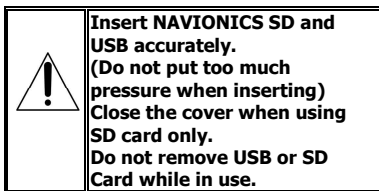

2-4 Chart Selection

You may choose to display one map from 2 (NAVIONICS, SAMYUNG MAP)

Follow the instruction for selection of map.

- 1 Hold down to **MENU**.
- 2 Select system setting
- 3 Select the chart you wish to display.

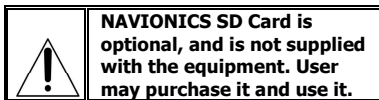

2-5 Simulation

Simulation Mode is great for practicing the actual use of a product when the satellites signals and internal alarms are not available. Under the simulation mode, the unit ignores the GPS antenna sensor's data.

2 simulation modes are available:

- Standard: Allows a user to set speed, bearing, route manually and navigate virtually.
- Demo: Function which allow boat to navigate by following the simulation route provided by the unit.

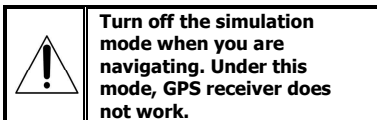

2-6 Data Bar

Data bar displays useful navigational information at the top of the display

| | | | | |
|--------------|-------|-----|-----|-----------|
| 35°05.152'N | ▲ SOG | 0.0 | kn | 03/Mar/11 |
| 129°04.278'E | ▲ COG | 110 | 위시각 | 23:31 |

Displaying Data bar

- 1 Press **MENU** and select **Data bar**.
- 2 Select Data bar

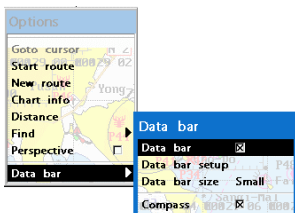

Setting the data displayed in the bar

- 1 Press **MENU** and select Data bar.
- 2 Select Data bar then Data bar setup
- 3 Move the cursor key to select the data field you wish to change and press **ENTER**.
- 4 Select Data type.
- 5 Select the desired data you wish to display in the field then press **ENTER**.
- 6 Repeat above steps if necessary.

Selecting the data bar size

- 1 Press **MENU** and select Data Bar
- 2 Select the Data bar size.
- 3 Select the desired size of data bar

[Large]

| | | | | | | | |
|--|------|-------|--------|---------|------|------|----|
| 300 310 320 330 340 350 | N | 10 | 20 | 30 | 40 | 50 | 60 |
| 40°30.572'N + 073°52.895'W + AIS Not connected | | | | | | | |
| COG | --- | SOG | --.--- | kn | Volt | 13.9 | V |
| --/--/-- | Time | --:-- | Depth | ---.--- | ft | | |

[Small]

| | | | | | | | |
|--|------|-------|--------|---------|------|------|-----|
| 300 310 320 330 340 350 | N | 10 | 20 | 30 | 40 | 50 | 60 |
| 40°29.314'N + 073°52.777'W + AIS Not connected | | | | | | | |
| COG | --- | SOG | --.--- | kn | Volt | 13.8 | V |
| --/--/-- | Time | --:-- | Depth | ---.--- | ft | SPD | 0.3 |

Tip: If you select None for all data fields, the data bar will disappear to save the space for the chart.

Tip: Different data bar gets set for 4 different windows.

2-7 Compass

The chart plotter computes compass direction from the constellation of GPS satellites. It is shown at the top of screen.



For easy recognition, there is a compass needle at top right side.



When the compass is displayed, COG is always displayed in data field. Also when you are navigating to a point, COG and BRG is always displayed in data bar.



Tip

COG – The course your vessel is heading

BRG – The direction from your current position to the destination.

To turn the compass off and on

1 Press **MENU** and select Data bar.

2 Check compass.



2-8 Multi Window Display

Chart plotter can display up to four windows at a time.

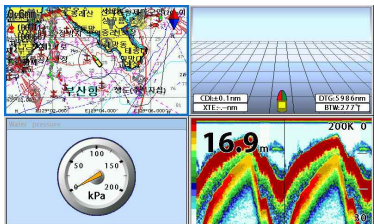

+ Adding a window

- 1 When chart display or any other function is under use, press **PAGE** and use **←** **→** to select adding window
- 2 Select the window you wish to add.



↕ Changing window size

- 1 Press **PAGE** and select Split icon on bottom
- 2 Press **←** or **→** to change the size of the windows

⊖ Removing the window

- 1 Press and hold down **PAGE** to select a window you wish to remove.
- 2 Press **PAGE** and select Remove icon to remove.

↻ Replacing windows on the display

- 1 Press **PAGE** and hold to switch the window.
- 2 Press **PAGE** and select Replace icon
- 3 Select icon you want to display and press **ENTER**

Active window

If more than one windows are displayed, the active window has blue border around it. If you wish to activate other window, press and hold **PAGE**.

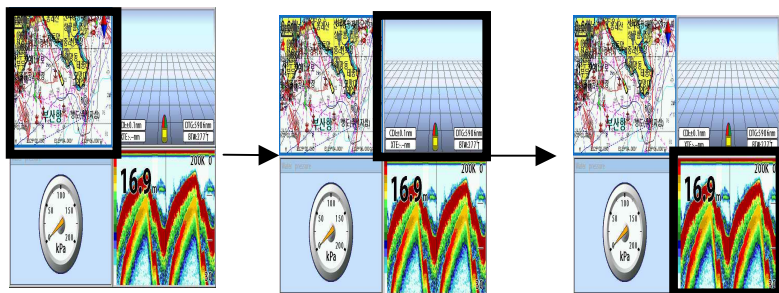

It is important to know which window is active as each window's function can be used from the multi-screen.

Favorite displays

The most commonly used windows are called favorite displays and up to six windows may be saved. Also each favorite window can have data bar and compass.



Displaying favorite display

- 1 Press **PAGE** twice
- 2 When window above pops up, select a desire display you want.

Adding a favorite display

- 1 Organize a window you want
- 2 Press **PAGE** to view the main window.
- 3 Select Save icon at the bottom.
- 4 To add the favorite display, select Display list. If you select the favorite display from the list, the selected display will be shown.

2-9 User Line Drawing

The user may draw a line or set the Mark using this function.

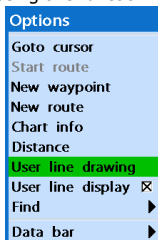

Up to 999 Lines, marks, characters could be inserted. When you press **MENU** from the User Line Drawing, it will show you the Options. From Option, you may edit, set the color or delete the line.

Press **MENU** and select User Line Drawing.

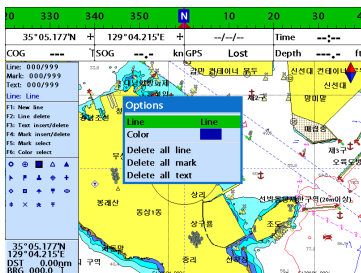

3 General Operation

3-1 Power on and off

Power on

Press **(D)** and hold until the display shows the start up page. Press **(ENTER)** to accept the warning screen.

Power off

Press and hold **(D)**. It will start a count down. If you do not release the button before it reaches zero, the chart plotter will remain On.

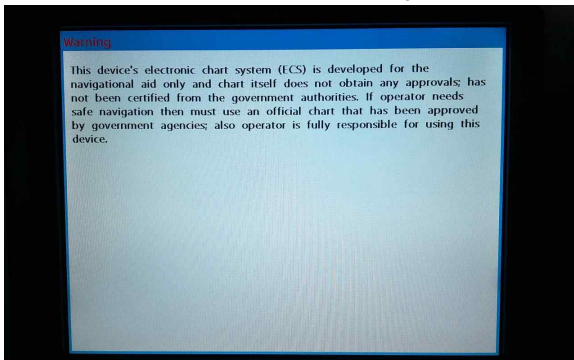

3-2 Brightness, night mode and Background

You may change the screen setting of the display. To do so, press **(D)** shortly.

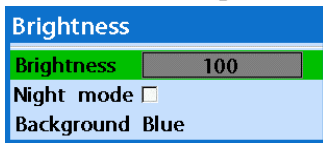

Brightness

To adjust the brightness, select Brightness, and press **(←)** to dim or **(→)** to brighten.

Press **(ESC)** after adjustment.

Night mode

GPS chart plotter has been programmed to allow you to view the optimum Chart window Initial setting has been done for the daytime view.

To change to the Night mode, move to Night mode and use **(→)** or **(ENTER)**.

Tip: It would be difficult to read the chart plotter under bright light if it is set at the night mode.

Background

You can make changes to the color of background to meet your preference. You may select the different colors which gives you the clearest viewing in your weather conditions and viewing angle.

3-3 Main window

To display the one window from the main page, press **PAGE** and select function you wish to show.



Note

1 Some function icons require optional units and sensors



Chart

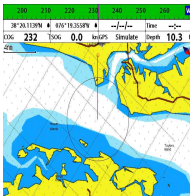

Echo Sounder

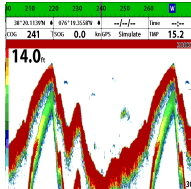

Video

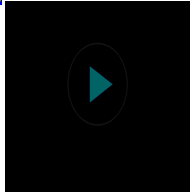

Highway

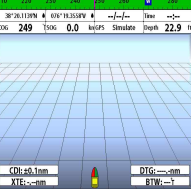

Data



Waypoint

| Name | Latitude | Longitude | Depth | Depth |
|-----------|--------------|---------------|-------|-------|
| WAYPOINT1 | 38°28'11.00N | 126°17'11.00E | 0.0 | m |
| WAYPOINT2 | 38°28'11.00N | 126°17'11.00E | 0.0 | m |
| WAYPOINT3 | 38°28'11.00N | 126°17'11.00E | 0.0 | m |
| WAYPOINT4 | 38°28'11.00N | 126°17'11.00E | 0.0 | m |



Routes

| Name | Date | Time | Lat | Long | Altitude |
|------|------|------|-----|------|----------|
| | | | | | |



Satellites

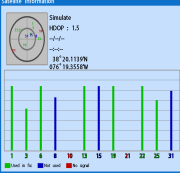

Tide

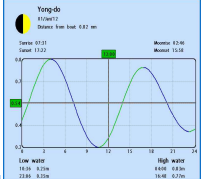

AIS

| ID | Course | Speed | MMSI | Heading |
|--------|--------|-------|-----------|---------|
| 021040 | 000.0 | 0.0 | 521000000 | 000.0 |
| 021040 | 000.0 | 0.0 | 521000000 | 000.0 |
| 021040 | 000.0 | 0.0 | 521000000 | 000.0 |
| 021040 | 000.0 | 0.0 | 521000000 | 000.0 |
| 021040 | 000.0 | 0.0 | 521000000 | 000.0 |
| 021040 | 000.0 | 0.0 | 521000000 | 000.0 |
| 021040 | 000.0 | 0.0 | 521000000 | 000.0 |
| 021040 | 000.0 | 0.0 | 521000000 | 000.0 |
| 021040 | 000.0 | 0.0 | 521000000 | 000.0 |
| 021040 | 000.0 | 0.0 | 521000000 | 000.0 |



DSC

| Date | Latitude | Longitude | MMSI | Name |
|------|----------|-----------|------|------|
| | | | | |



Navtex

| Date | Magnitude | Frequency |
|------|-----------|-----------|
| | | |



Engine Errors

| Engine | Fault | Date |
|--------|-------|------|
| | | |



3-4 Chart

Chart window shows all the navigational relevant data of S-MAP and NAVIONICS (buoys, lights, cables, depth sounding, marinas, tide station)

3-4-1 Chart Window

To go to the Chart window:

Press **PAGE** and select Chart icon.

A typical Chart window shows:

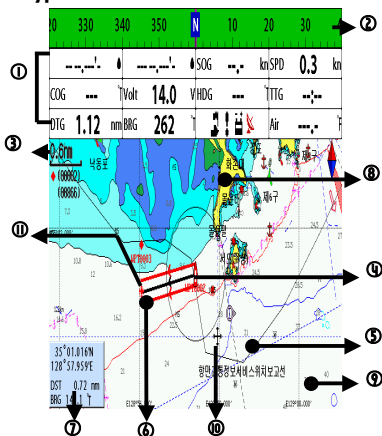

- ① Data bar. You may change the data displayed on the data bar.
- ② Compass
- ③ Chart scale
- ④ Boat position
- ⑤ Boat track
- ⑥ Boat course and CDI lines
- ⑦ Distance and bearing of cursor from boat
- ⑧ Land
- ⑨ Sea
- ⑩ The cursor
- ⑪ A typical waypoint



The built-in world chart does not show enough detail for navigation. When you use the Chart Plotter to navigate, always use a chart card which covers the region.(NAVIONICS)

3-4-2 Latitude and Longitude

Latitude and longitude coordinates define the position on earth and can be displayed on data bar.

In the data bar, vessel's position will show as below

47° 43.000' N or S Latitude
003° 21.656' E or W Longitude

| | | | |
|--------------|---|---------------|---|
| 47° 43.000'N | • | 003° 21.656'W | • |
|--------------|---|---------------|---|

However, if you move the cursor, the latitude and longitude of the point where cursor is on, will be shown as below in the data bar

47° 43.325' N or S Latitude
003° 20.607' E or W Longitude

| | | | |
|--------------|---|---------------|---|
| 47° 43.325'N | + | 003° 20.607'W | + |
|--------------|---|---------------|---|



Tip

Latitude: The angular distance north or south from the equator of a point on the earth's surface, measured on the meridian of the point

Longitude: Angular distance east or west on earth's surface, measured by the angle contained between the meridian of a particular place and some prime meridian.



When reading the position of the boat from the data bar, make sure there is no cursor on the chart.

3-4-3 Chart scale

To view the chart in more detail, press or . To view the chart more widely, press or . The chart scale is displayed on the chart.



3-4-4 NAVIONICS Search

To use this function, insert NAVIONICS SD card and the presetting of displaying NAVIONICS map is required.

To find a port by name:

- 1 Press
- 2 Select Find then Port by name.
- 3 Press or to select letters then press for next letter
- 4 Press after entering the name of port.
- 5 After searching, select a nearest port then the cursor will be placed on the port you have selected on the chart window.
- 6 Repeat Steps 2~3 to display the information.

To search port & service:

- 1 Press
- 2 Select Find then Port & service
- 3 Select a service you want to find.
- 4 After searching, if you select the nearest service, cursor will be placed on the area you selected on the chart window.



S-MAP does not support this function. (Refer to 2-4 for chart selection)



3-4-5 SAMYUNG Map Search

This function is available when it has been set for SAMYUNG map to be displayed.

To find port & service:

- 1 Press **MENU**
- 2 Select Find then Port.
- 3 Press **▲** or **▼** to select port then press **ENTER**.
- 4 After selection of port, if you select the nearest port in the list, then the cursor will place on the port you have selected on the chart window.

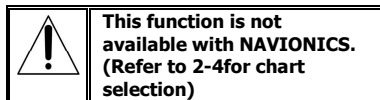

3-4-6 Symbols and information

Insert NAVIONICS SD card and set the setting so that the NAVIONICS MAP is displayed in order to use this function.

Various symbols and information would be displayed. On some objects such as a port, you can see a picture of landscape layout.

To display information:

- 1 Move cursor on an icon to display its name.
- 2 Press **MENU** and select Chart info.
- 3 To highlight an item, move cursor key and press **ENTER**.
- 4 The related information to the item will appear at the bottom window.

[Chart info]

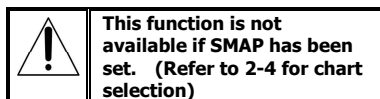
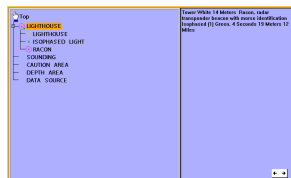

[Data box to Chart Symbols]

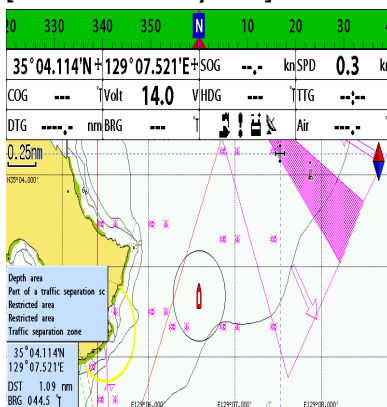

3-4-7 Introduction to navigating

Use the navigation chart to plan your course, view map information, and as a navigational aid.

This unit has two ways of navigating, going straight to a waypoint or following a route (a group of waypoints).

3-4-8 Going to a waypoint or to a point on the chart

A waypoint is a particular location on a voyage whether it is a starting, intermediate or destination point. A waypoint is the simplest piece of information your equipment requires to get you to a destination. In the shortest distance possible. This unit can save up to 10,000 waypoints.

Go to Cursor Option

- 1 Press **PAGE** and select the Chart window.
- 2 Move the cursor to the destination point.
- 3 Press **MENU** and select Go to cursor to start navigating.

Goto WPT Option

- 1 Press **PAGE** and select the Chart window
- 2 Move the cursor to place cursor on a waypoint.
- 3 Press **MENU** and select Goto WPT to start navigating.

3-4-9 Following a route

Often a trip from one place to another involves several course changes, requiring a series of route points (waypoints) which you navigate to, one after another. The sequence of waypoints leading to the ultimate destination is called a route. You can save up to 100 routes and a route may consist of 100 waypoints...

Option to Start Route

- 1 Press **PAGE** and select the chart window.
- 2 Press **MENU** and select Start Route.
- 3 Move cursor keys to select a route to start navigating.
- 4 Select Forward or Reverse to decide which direction you want to navigate.

Route Window Option

- 1 Press **PAGE** and select the routes window
- 2 In the route window, mover the cursor to highlight a route you want to start navigating to.
- 3 Press **MENU** and select start
- 4 Select Forward or Reverse to decide which direction you want to navigate.

Cancelling Navigating

- 1 Press **PAGE** and select chart icon.
- 2 Press **MENU** and select Cancel Goto.



Make sure the course does not pass over land or dangerous waters.

Option to create Route

- 1 Press **PAGE** and select the chart window.
- 2 Select New route.
- 3 Name a route name.
- 4 Move cursor keys to select a waypoint.
(Repeat this step as much as you need)
- 5 Press **MENU** and select Add.
- 6 Press **ESC**.
- 7 Repeat 2-4 steps of Route window option.

Skipping a waypoint

- 1 Press **MENU** and select Skip.
- 2 Repeat above step if necessary.

Cancelling a route

- 1 Press **PAGE** and select the chart window.
- 2 Press **MENU** and select Cancel route.

3-4-10 Distance and bearing calculator

The unit can show the bearing and the length of leg and the total distance of legs.

Setting Legs

- 1 In the chart window, press **MENU** and select **Distance**. Information is displayed on window showing bearing/leg distance/total distance at the bottom left side of display.
- 2 Move the cursor to the starting point of the first leg and press **ENTER**.
- 3 Repeat step 2 for more legs
- 4 Press **ESC** to exit.

Deleting last leg

- 1 Press **MENU** then select remove
- 2 Repeat above step if you want to remove more legs.

Saving route

- 1 Set all the legs then press **MENU** and select **Save**.
- 2 Enter a route name by pressing **▲** or **▼** to select a letter then press **▶** for next letter.
- 3 Press **ENTER** to save the new route.

Bearing and distance

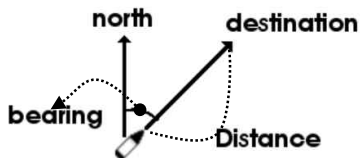

3-4-11 Projected course

The projected course shows you how far it can go at given time and speed. This function is useful to avoid collision with other vessels.

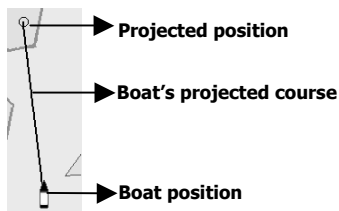

3-4-12 Finding a chart symbol

From the chart, when you hold down to **ENTER**, the Mark window will show.

- From Mark: select the symbol of mark
- From Color: select color of mark
- From Insert: Preset the longitude and latitude of the place you wish to create the mark
- User may also delete mark, delete color of mark, delete coordinate and set the number indication.

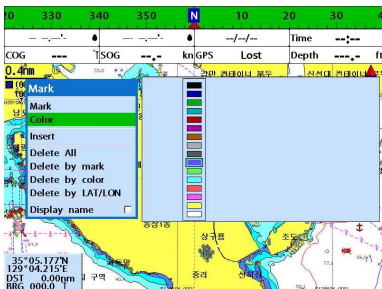

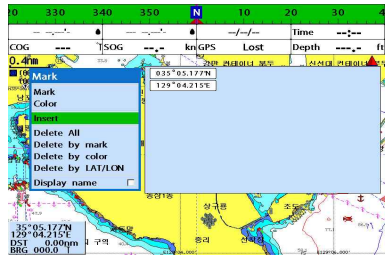
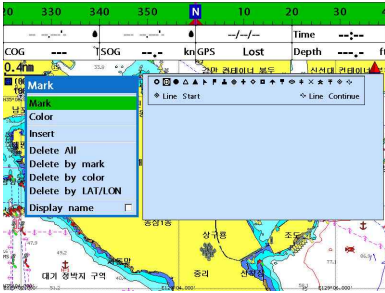

3-4-13 Setting Tracks in the chart window

To set the tracks on chart window, press and hold **ESC** (Refer to 4-5 Track Setting)

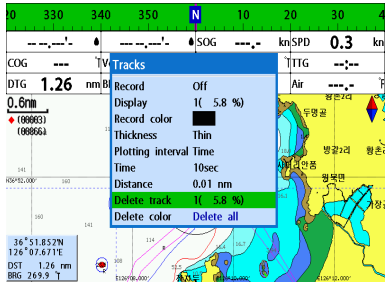

3-4-14 3D MAP

Pressing the **F5** shows the menu to allow you to set 3D map

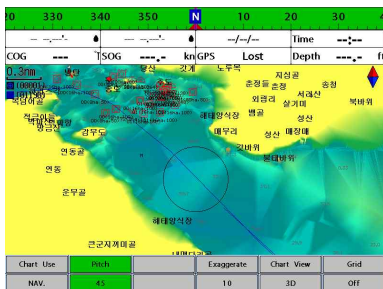
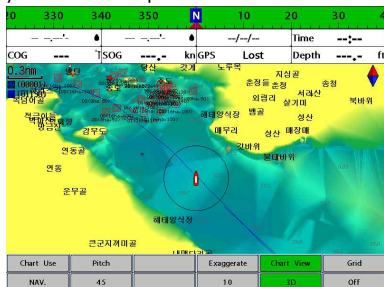

Use of Map: You may select both navigation and fishing, under fishing operation, only geographical information gets displayed and when navigating, both information and mark gets displayed.

Pitching: Display can be tilted. From 3D menu, use **F1** or directional key to place the green mark on the map on use, and change the levels. Using +, - keys allows adjustable range larger.

Enlarge the range: If you raise the value of range, the value gets displayed exaggerated. From 3D menu, press

F4 Or directional key to place green mark on the range enlargement, then use directional key to adjust the levels. Using +, - keys allows adjustable range larger.

Map Display: You may select between 3D and 2D

Grid: You may turn and turn off the grid



3-5 VIDEO

You may use the media cable to connect with CCTV, S-VIDEO or download the files from SD Card, USB to play it on the video function.

To activate the video function, follow the instruction in order

1 Hold down to **MENU** to select the system setting category.

2 Select the additional component and select video.

3 Press **ESC**, from general display press **PAGE** then select video function

3-5-1 Option

External video option

When you press **MENU** option displays.

Input: You may select from composite-1, composite-2, S-VIDEO.

Brightness: You may adjust the brightness level of display

Contrast: You may adjust the contrast.

Saturation: You may adjust the vividness of color.

Hue: You may adjust the hue of the color.

Movie: When you select this menu, it will take you to the menu where the files are saved and could be played from SD card and USB

Data bar: Refer to (2-7) compass

Refresh: Initial value gets set.

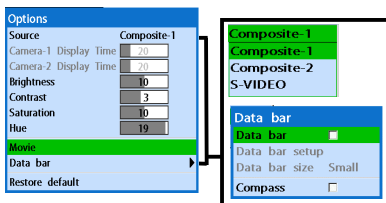

Movie option

When you press **MENU**, option displays

Open: Opens the file from SD card and USB.(shortcut: **↵**)

Play: Play the file (shortcut: **ENTER**)

STOP: Returns to the beginning of the file while playing

REPLAY: Plays the file from the point where it was paused (Shortcut: **ENTER**)

PAUSE: Pauses the file while playing. (Shortcut: **ENTER**)

BACK: Move 10 seconds backwards while file is playing(Shortcut: **⏮**)

FORWARD: Move 10 seconds forward while file is playing (shortcut: **⏭**)

PREVIOUS: Plays the file above the current playing file. (shortcut: **⏪**)

NEXT: Plays the next file of the current playing file. (shortcut: **⏩**)

Subtitle: When you tick the box, the subtitle displays for the playing video file.

REPEAT: The file repeats itself when it ends

VOLUME: You can adjust the volume of the current playing file

When you mute it, you can't hear the sound.

External video: It goes to the option where you can use external cam or S-VIDEO.

DATA BAR: Refer to (2-7) compass

REFRESH: Initial value gets set

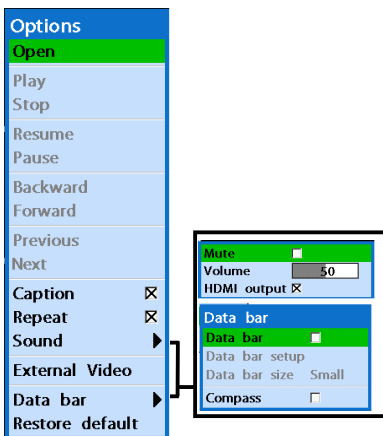



3-6 Sonar

It is possible to use the Sonar function when it is connected to the transducer.

Follow the following steps to activate the Sonar function.

- 1 Press **MENU** and hold, select System Setting
- 2 Select additional component and select Sonar.
- 3 Press **ESC** and press **PAGE**. Then select Sonar. This will move to the Sonar

3-6-1 Display Description

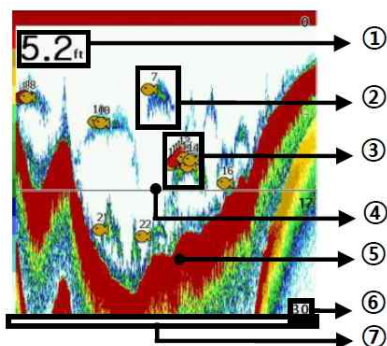

- ① Depth
- ② Single Fish: Fish symbol with depth
- ③ School of fish
- ④ Depth line
- ⑤ Bottom: Hard bottoms such as rock and coral shown as wide bands. Soft bottoms such as mud, weed and sand shown as narrow bands.
- ⑥ Range
- ⑦ Display moves from right (latest sonar record) to left (old sonar record).

3-6-2 Mode

You may choose from two modes.

- **Auto mode:** This function is used while vessel is moving. The unit adjusts the setting of bottom of water according to the environment automatically
- **Manual mode:** This function is used when the user wants to adjust the setting to fit the environment. This brings the best result for the user.

To change the mode

- 1 Press **MENU** then select Gain.
- 2 Select Mode then choose Manual or Auto mode.
- 3 Press **ESC** until it returns to the Sonar window.



3-6-3 Single or Dual Frequency Fish finding

Sonar frequencies

The unit has dual frequency, 200kHz and 50kHz to detect various bottom conditions. 1 Press **MENU**, select **Frequency**. 2 Select one frequency

High frequency (200kHz)

The higher ultrasonic signal, the better is the resolution. For this reason the 200 kHz frequency is ideal for detailed observation of fish schools.

Low frequency (50kHz)

The lower frequency signal is, the wider is the detection area. Therefore, the 50kHz frequency is useful for general detection and judging bottom condition.

Mixed frequencies (200kHz / 50kHz)

The Mixed frequency combines the 200 kHz and the 50 kHz in the Sonar window. The 50kHz picture appears on the left and the 200kHz picture on the right.

The display is useful for comparing the same picture with two different frequencies.

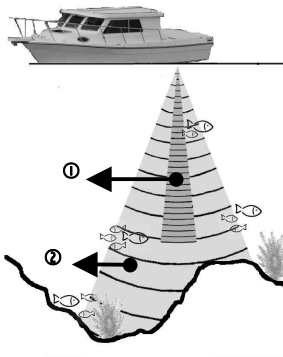

- ① High Frequency (200 kHz)
- ② Low Frequency (50 kHz)

3-6-4 Range

Range is the depth of water displayed on the sonar window. The basic range may be chosen in Auto or manual mode.

Auto: When the mode is set to Auto, the unit adjusts the depth automatically for the best performance. This option is recommended for normal operation.

Manual: When the mode is set to Manual, the unit only displays the depth of water at a given range. That means the sea bottom might not be displayed in the sonar window or it might display half of display in white because range is more important than sea bottom depth. As shown in below images.

To set the manual mode in the sonar window:

- 1 Press **MENU**, select **Range**.
- 2 Select a mode you want and press **ENTER**
- 3 If you select the manual mode, press **▲** or **▼** to change value of max displayed depth.

[When the set depth is too low]

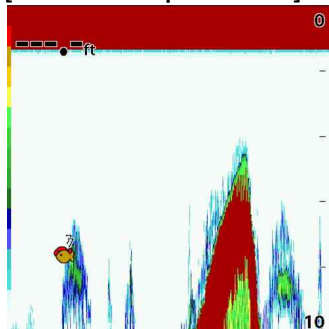

[When the set depth is too high]

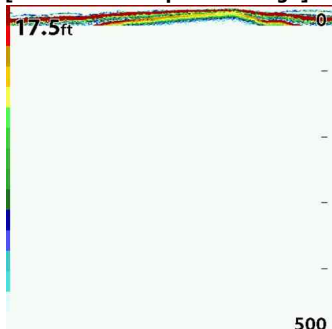

3-6-5 Gain

The Gain Mode

The gain is a signal strength received from the transducer and the threshold is the level of ultrasonic that is ignored by a set value. When you use the manual mode and threshold, the values of gain and threshold need to be set very carefully.

In the Gain window, you can set gain mode and threshold.

| Gain | |
|-------------|------|
| Mode | Auto |
| 200kHz | 10 |
| 50kHz | 10 |
| Threshold ☒ | |
| 200kHz | 20% |
| 50kHz | 20% |

To change a mode,

- 1 Press **MENU**, select **Gain**.
- 2 Select a mode.
- 3 If you select a **Manual** mode, adjust each frequency gain value by pressing **←** or **→**. Even though you select the **Auto** mode, it will be changed to manual mode if you change the values of frequency.

3-6-6 Sonar window display

Five sonar display windows are available and each display window has unique characteristics. Select a display window depending on your needs. The default display is No split.

To change a Sonar display window in the sonar window:

- 1 Press **MENU**, select Window mode.
- 2 Select the sonar display you want.

No split: Display Sonar history at a given frequency (50 or 200 kHz) (see section 3-5-7)

Split zoom: This mode expands chosen area of the normal picture in full vertical size on the left-half part of the window.

Full screen zoom: Display a zoomed section on full screen (see section 3-5-8)

Split bottom: Display Sonar history and a bottom trace focus in a zoomed section (see section 3-5-9)

Split 50/200: Display the 50 kHz sonar history on the left and the 200 kHz sonar history on the right. This display is useful for comparing the same history with two different frequencies. (see section 3-5-10)

3-6-7 No split

No split window displays a sonar history at a given frequency (50 or 200 kHz)

Low Frequency (50 kHz)

The 50 kHz frequency is ideal for detecting the wider area which means low frequency is useful for general detection and judging bottom condition.

High Frequency (200 kHz)

The 200 kHz frequency is ideal provide a better resolution which means it is ideal for the observation of fish or fish schools.

To set a frequency for this display:

- 1 Once you select **No split** window, Press **MENU**.
- 2 Select the sonar icon then **Frequency**
- 3 Select a desired frequency

Split A-Scope: Display Sonar history and echo strength (see section 3-5-11)

You can change the split ratio if the window is split.

- 1 Press **MENU** and select **Window split**.
- 2 Press **←** or **→** to adjust the ratio.
- 3 Press **ENTER**.

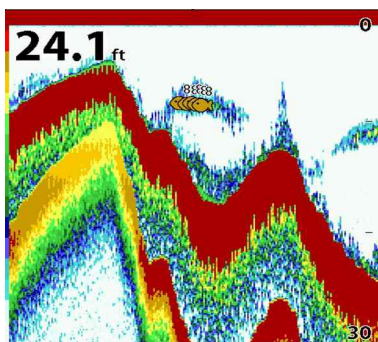
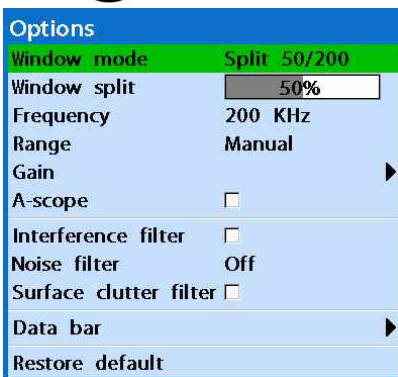

You can also review old sonar records, press **←** and **→** to review the history. To return to current scanning, press **ESC**.

3-6-8 Split zoom and Full Screen zoom

Split zoom

Split zoom mode expands selected area of the single frequency by VRM(Variable Range Mark). The left side displays zoomed section of current sonar record. The VRM of right side indicates the zoom section area.

- Press ▲ or ▼ to change the zoom range.
- Press Ⓜ or Ⓜ to change the depth range.

Bottom lock

If **Bottom lock** is on, the zoom depth (the depth of the zoom section) is adjusted automatically so that the bottom is always displayed in the zoom section.

- To turn Bottom lock on or off press **MENU**

Full Screen zoom

Full screen zoom displays only the zoom section of split zoom.

[Split zoom]

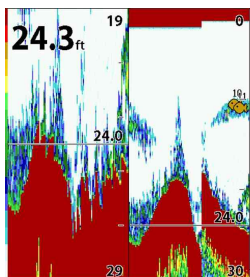

[Bottom Lock]

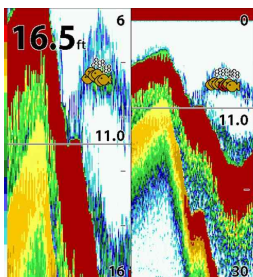

[Full screen zoom]

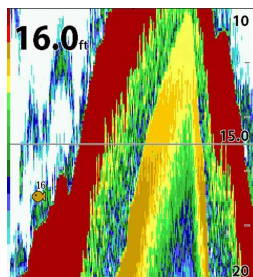

3-6-9 Split bottom

Split bottom display provides a normal picture on the right half and a selectable range over and below the bottom line is expanded onto the left half of the screen. This mode is useful for detecting bottom fishes.

- Use the ◀ or ▶ keys to adjust the zoom range.
- Press Ⓜ or Ⓜ to change the range
- The VRM moves up and down to calculate the bottom depth automatically.

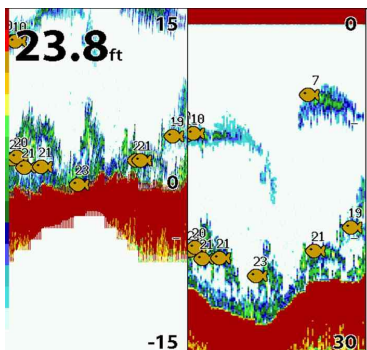

3-6-10 Split 50/200

The 50 kHz display appears on the left and the 200 kHz appears on the right. This dual frequency display is very useful for comparing the same scanning with two different frequencies.

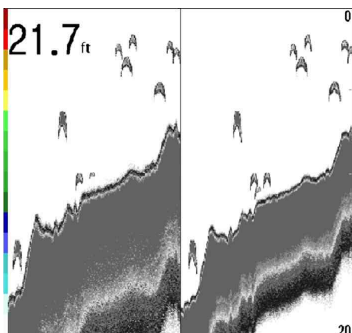

3-6-11 Split A-Scope

This display shows echoes at each transmission with amplitudes and colors proportional to their intensities; on the right of the screen it is useful for estimating the kind of fish schools and bottom nature.

Echo strength color code varies from weakest (blue) to strongest (red).

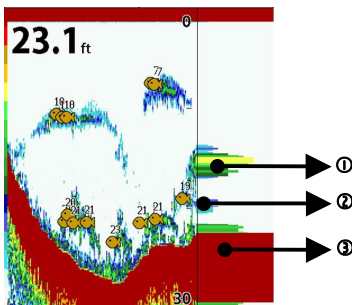

- ① Echoes from fish and the bottom
- ② Unwanted noise echoes.
- ③ The strongest echo, usually from the bottom.

3-7 Highway

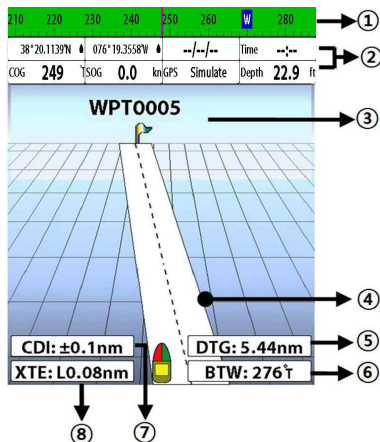

The **Highway** window shows a 3D view of the vessel traveling through the water when navigating to a destination point.

To go to the **Highway** window, press **PAGE** and select **Highway** icon.

The **Highway** window shows:

- ① Compass.
- ② Data bar.
- ③ Destination waypoint.
- ④ Boat's plotted course to destination.
- ⑤ DTG scale (Distance To Go).
- ⑥ BTW scale (Bearing to waypoint).
- ⑦ CDI (Course Deviation Indicator).
- ⑧ XTE scale (Cross Track Error).

3-8 Data

The Data window displays all the information you need during navigation such as water, engine, fuel related information, etc. To select the data window, press **PAGE** or press **DATA** icon.

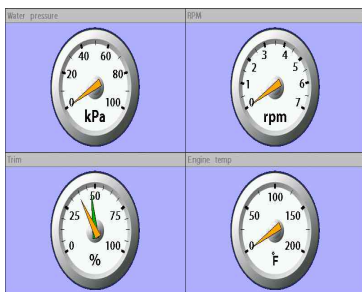

Selecting a data layout

The data window can show one of seven gauge layouts.

To select a layout from the data window:

- 1 Press **MENU** and select data Layout.
- 2 Select one layout.

Changing a gauge in one selected

To change a gauge displayed in a layout in Data display.

- 1 Press **MENU** and select Data Setup then the upper left side gauge will be highlighted.
- 2 Select a gauge you want to change and select Gauge type.
- 3 Select a data type you want to display.



3-9 Waypoints

A waypoint is a particular location on a voyage whether it is a starting, intermediate or destination point. A waypoint is the simplest piece of information the unit requires to get you to a destination in the shortest distance possible. This unit can save up to 10,000 waypoints.

To display waypoint list, press **PAGE** and select **Waypoint** icon.

| Waypoints | | | | |
|-----------|---------------------------|--------------|--------------|--|
| Name | Latitude Longitude | DST BKG T | Drgr Disp | |
| MOB00002 | 38°20.113N 076°19.355W | 0.0 | No | |
| MOB00003 | 38°20.113N 076°19.355W | 0.0 | H-N | |
| MOB00004 | 38°20.113N 076°19.355W | 0.0 | No | |

To select To Page Up/Down

3-9-1 Creating a new waypoint

To create a waypoint from the chart window

There are two ways to create a new waypoint from the chart window as described below:

- 1 Press **MENU** on at the current boat position.
- 2 Move the cursor to a point where you want to create a waypoint and press **ENTER**.

To create a waypoint from the waypoints window

- 1 Press **PAGE** and select waypoint
- 2 Press **MENU** and select **Create**.
- 3 Enter waypoint data, change alphanumerical name, choose between 48 icons, 16 colors and display option.
- 4 Select **Save**.

3-9-2 Moving a waypoint

To move a waypoint from the chart window

- 1 Move the cursor to place it on the waypoint you want to move. (If you move the cursor on the waypoint correctly, waypoint information will be displayed at the bottom left).
- 2 Press **MENU** and select **Move**.
- 3 Move the cursor to a point where you want to move and press **ENTER**.

To Move a waypoint from the waypoints window

- 1 Highlight a waypoint you want to move.
- 2 Press **MENU** and select **Edit**.
- 3 change the existing latitude and longitude to new position.
- 4 Select **Save**.

3-9-3 Editing an existing waypoint

To Edit a waypoint from the chart window

To Edit a waypoint from the waypoints window

- 1 Move the cursor to the waypoint you want to edit. (If you move the cursor on the waypoint correctly, waypoint information will be displayed at the bottom left)
- 2 Press **MENU** and select **Edit**.
- 3 Edit waypoint data as you need and press **ENTER**.

3-9-4 Deleting a waypoint

To delete a waypoint from the chart window

- 1 Move the cursor to the waypoint you want to delete. (If you move the cursor on the waypoint correctly, waypoint information will be displayed at the bottom left)
- 2 Press **MENU** and select **Delete**.
- 3 Select **Yes**.

- 1 Move cursor key to highlight a waypoint you want to edit.
- 2 Press **MENU** and select **Edit**.
- 3 Edit waypoint data as you need and press **ENTER**.

Deleting a waypoint from the waypoints window

- 1 Move cursor key to highlight a waypoint you want to delete.
- 2 Press **MENU** and select **Delete**.
- 3 Select **Yes**.

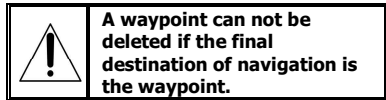

3-9-5 Find a waypoint

To find a waypoint from the chart window

Finding waypoints from the chart window is a simplified function.

- 1 Press **MENU** and select **Find**.
- 2 Select **Waypoints**.
- 3 Move cursor key to highlight a waypoint you want to find and press **ENTER**.

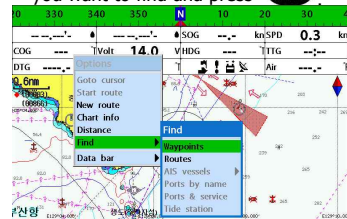

To find a waypoint from the waypoint window

Finding waypoints from the waypoint window is provided by a full function.

- 1 Press **MENU** and select **Find**.
- 2 Press **▲**, **▼**, **◀** or **▶** to find a waypoint name.
- 3 Select **ENTER**.

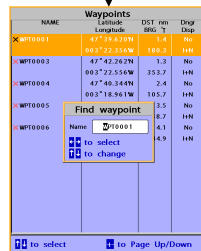
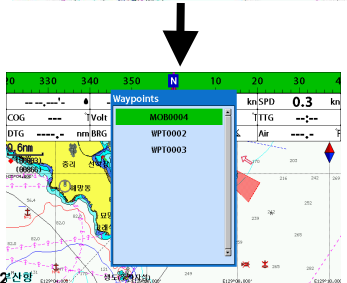
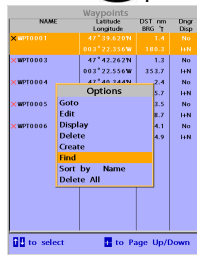

3-9-6 Sort Waypoints

To change the order of displayed waypoint list:

- 1 Press **MENU** and select **Sort by**.
- 2 Select a sort type.

3-9-7 Deleting all waypoints

- 1 In the waypoints window, press **MENU** and select **Delete all**.
- 2 Select **Yes**.



3-10 Routes

A trip from one place to another often involves several course changes, requiring a series of waypoints which you navigate to, one after another. The sequence of waypoints leading to the final destination is called a route. The unit can automatically advance to the next waypoint on a route. So you do not have to change the destination waypoint repeatedly.

The unit has the capability to store 100 routes with maximum of 100 waypoints each.

To display the **Routes** window, press **PAGE** and select the **Routes** window.

| Routes | | | | |
|----------|---------|---------|------|----------|
| Name | Start | End | Legs | DST(0nm) |
| ROUTE 01 | WPT0001 | WPT0003 | 2 | 02. |
| ROUTE 02 | WPT0003 | WPT0006 | 3 | 10. |
| ROUTE 03 | WPT0001 | WPT0003 | 3 | 07. |
| ROUTE 04 | WPT0003 | WPT0006 | 3 | 10. |

to select to Page Up/Down

3-10-1 Managing a route from the chart window

Creating a new route window

- 1 Press **MENU** and select **New route**.
- 2 Enter the new route name using cursor key and press **ENTER**.
- 3 On the **Chart** window, move the cursor to the position of the starting waypoint in the Route and press **ENTER**.
- 4 Move the cursor keys to the position of next waypoint and press **ENTER**.
- 5 Repeat step 4 to enter more waypoints.
- 6 Once you entered the last waypoint in the route, press **MENU** and select **End**.

Editing a waypoint in route while creating a route

- 1 Move the cursor to the waypoint you want to move.
- 2 Press **MENU** and select **Move**.
- 3 Move cursor to a position where you want to move the waypoint and press **ENTER**.

Deleting a last waypoint from the route while creating a route

- 1 Press **MENU** and select **Delete**.

Deleting a waypoint from the route while creating a route

- 1 Move the cursor to the waypoint you want to remove.
- 2 Press **MENU** and **Remove**.

Tip: Even though you deleted a waypoint in the route, the waypoint still remains in the waypoint list.

Inserting a waypoint while creating a route

- 1 If you want to insert a waypoint between waypoints which will be just after the one you want to insert.
- 2 Press **MENU** and select **Insert**.
- 3 Move the cursor to the new inserted waypoint and press **ENTER**.

Inserting a waypoint in front of starting waypoint while creating a route

- 1 Move the cursor to the starting waypoint
- 2 Press **MENU** and select **Insert**.
- 3 Move the cursor to the new start location and press **ENTER**.

| Routes | | | |
|--------|----------|--------------|------------|
| Name | ROUTE 04 | | |
| Leg | Waypoint | Distance(nm) | Bearing(D) |
| 1 | WPT0003 | | |
| 2 | WPT0005 | 3.6 | 239.0 |
| 3 | WPT000 | | 114.9 |

Insert waypoint

WPT0001
 WPT0003
 WPT0004
 WPT0005
 WPT0006
 WPT0007
 WPT0008
 WPT0009
 WPT0010
 WPT0011
 WPT0012
 WPT0013

to Page Up/Down

to Page Up/Down



3-11 Satellites

3-11-1 Satellite Information

Acquiring GPS signals

When the unit is first turned on it will take some time for the GPS signal acquiring. After signals are received, the unit will automatically find a position of boat in the chart window.

Satellite information window

The satellite window displays different information about the GPS satellites and GPS position as below.

To go to the satellite window, press **PAGE** and select **Satellite** icon.

The satellite window shows:

- ① Ship's Coordinates.
- ② Time received GPS satellites.
- ③ Date received GPS satellites.
- ④ HDOP: Horizontal Dilution of Precision. It is a parameter indicating the accuracy of the GPS.
- ⑤ Location of GPS Satellites.
- ⑥ GPS signal strengths status in graph.

Press **ENTER** to display GPS signal information from GPS satellite in NMEA0183 data format at the GPS signal strengths status display. To return to GPS signal strengths status display, press **ENTER** again.

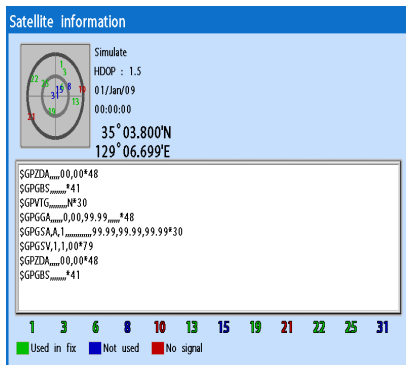
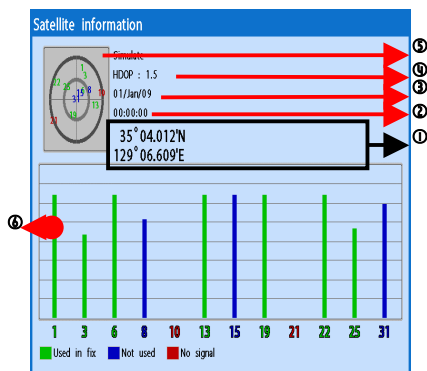



3-12 Tides

The **Tides** window is useful for boaters that are concerned about the height of the water or by fisherman that wish to know the tide and moon phase of a specific date.

Displaying a tide information from the chart window

- 1 In the **Chart** window, press **MENU**.
- 2 Select **Find and Tide station**.
- 3 Press **▲** or **▼** to move cursor and select a tide station
- 4 Press **▲**, **▼**, **◀** or **▶** to the position of selected tide station and press **ENTER**.
- 5 Select **Tide height station** to display the information
- 6 Press **ESC** to exit.

Displaying tide station information in the tides window

- 1 Press **PAGE** and select **Tides** window.
- 2 Select **Tide height station** to display the information.
- 3 Press **ESC** to exit.

Tip: The unit only displays the tide information nearest your boat in the tides windows.

Choosing the date of the tide information.

- 1 In the Tides window, Press **MENU** and select one of the following options.
 - **Set date:** manually set a date.
 - **Today:** automatically set the date of today.
 - **Next day:** automatically set the date of today.
 - **Prev day:** automatically set the date of yesterday
- 2 Press **ESC** to return to the window

The tides window shows data for the chosen date

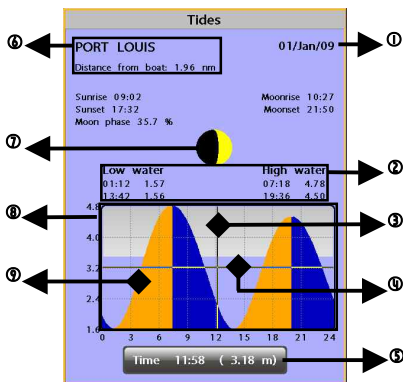

- ① Current time and chosen date for display.
- ② Data for the chosen date.
- ③ Tide height cursor, a horizontal dotted line. Press **▲** or **▼** to move cursor up and down.
- ④ Time cursor, a vertical dotted line. Press **◀** or **▶** to move cursor sideways.
- ⑤ Time of cursor and tide height at that time.
- ⑥ Tide station name and distance from boat.
- ⑦ Moon phase for moon at the current time on the chosen date.
- ⑧ Tide chart.
- ⑨ Tide height.



In case of SAMYUNG MAP is already set, it (Please refer to 2-4 how to select a map)

3-13 AIS

AIS is an Automatic Identification System for identification and localization of boat. AIS provide a means for boats to exchange and share boat data including identification, position, course, etc. This information can be displayed on the screen of you unit. AIS is intended to assist you to monitor other boats movements to improve safety and prevent collision.

AIS functions require an optional AIS unit to be installed.

To activate AIS function:

1. Press and hold **MENU** and select System Configuration icon.
2. Press **ESC** and press display from the top page and select AIS.

3-13-1 Viewing AIS Vessels

When the unit is connected to AIS unit which support NMEA0183 or NMEA2000, you can check other vessel that are equipped with AIS unit on the screen. To check AIS information place the cursor on the AIS object then AIS information displays at the bottom of window.

- ① AIS equipped vessel
- ② Dangerous Vessel
- ③ Projected Course
- ④ AIS equipped vessel Data Box
- ⑤ Range Rings

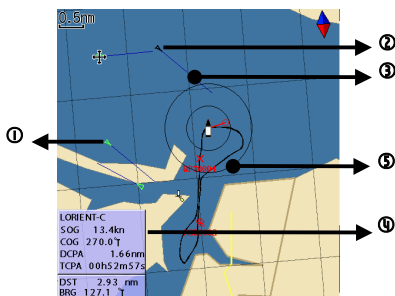

3-13-2 AIS Windows

To display the AIS windows:

- 1 Press display, and select **AIS** icon.
- 2 Press and hold display to select one of the two tabs: **Vessels** or **Messages** tab.
 - **Vessel:** show you all the AIS equipped vessel around you. (up to 200 vessels)
 - **Message:** show you all the messages related to safety from other AIS equipped vessels.

Caution : The display can show information for 250 vessels as maximum.

Sorting Vessels

- 1 Press **MENU**, select **Sort by**.
- 2 Select one of the options

Displaying an AIS vessel on the chart

To overlay AIS equipped vessel on the chart window:

- 1 Press **▲** or **▼** to select a vessel you want to display in **AIS** window.
- 2 Press **MENU** and select **Display**

Displaying AIS equipped vessel Details

- 1 Press **▲** or **▼** to select a vessel you want to display full AIS detail in the **AIS** window.
- 2 Press **ENTER** or press **MENU** and select **More Info**.
- 3 Press **◀** or **▶** to see more detail.

3-14-2 Poll

Poll

A compatible radio with the unit can request the position of other DSC VHF radio equipped vessels around its position. When the position of a vessel is received, the location is displayed on the screen and it is logged into Poll window

To display the **Poll** tab, press and hold **PAGE**.

Displaying an poll vessel in the chart window

- 1 Highlight a poll you want to display.
- 2 Press **MENU** and select **Display**.

Going to the poll vessel position

- 1 Highlight a poll you want to go.
- 2 Press **MENU** and select **Goto**.

Edit a distress waypoint

- 1 Highlight a poll you want to edit.
- 2 Press **MENU** and select **Edit Waypoint**.
- 3 Change data field and select **Save**

Tip: When receiving a poll from other vessel, it does not create a waypoint as a distress call

Deleting a poll

- 1 Highlight a received distress call you want to delete.
- 2 Press **MENU** and select **Delete**.

Deleting all poll

- 1 Press **MENU** and select **Delete all**.

Tip: Even though you delete a DSC call, the DSC waypoints still exist.

| DSC | | |
|---------------------|-------------------------------|-------------------|
| Distress | Poll | |
| Date Time | Latitude Longitude | MMSI NAME |
| 01/01/2009 12:42 | 36° 24.000'N 129° 34.000'E | 1111111111 --- |
| | | |
| | | |
| | | |
| | | |
| | | |
| | | |
| | | |
| | | |

4 Settings

The system menu mainly consists of settings which do not require frequent adjustment. To go to system menu, press and hold **MENU** then select the icon you want.



- ① System Configuration.
- ② SONAR.
- ③ Communication.
- ④ GPS.
- ⑤ Track & Log.
- ⑥ Memory.
- ⑦ AIS.
- ⑧ Alarms.
- ⑨ Others.



4-1 System Configuration Settings

To go to **System configuration**:

- 1 Press and hold **MENU**.
- 2 Select the **system configuration** icon.

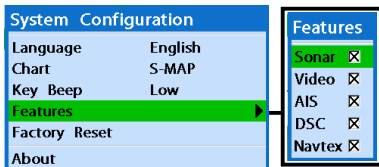

4-1-1 Language

Change the language for menus and data screens.

4-1-2 Chart Selection

Select a chart between S-MAP or NAVIONICS chart.

4-1-3 Beep volume

Select the level of beep sound.

4-1-4 Auto power

See section 3-1.

4-1-5 Features

When external devices are connected to the unit, the corresponding options need to be set.

4-1-6 Factory reset

When this option is selected. All settings of this unit returns to default factory settings.

4-1-7 Unit information

The unit information window shows:

- 1 Software version and release date.
- 2 NAVIONICS version.
- 3 Stored waypoints, routes and tracks count
- 4 Wiring information of connector.





4-2 Chart settings

To go to the chart settings:

- 1 Press and hold **MENU**.
- 2 Select the chart icon.

The image displays three sequential screenshots of a navigation system's chart settings menu. The first screenshot shows the 'Chart' menu with options: Rotation (Heading up), Palette (Sunlight), General, Land & Sea, Map Datum (WGS84), NMEA datum offset (Off), Map shift (Off), and Restore default. The second screenshot shows the 'NAVIONICS' settings menu with options: Plotter mode, Mixing levels, AntiClutter, Value added data, Lat/Lon grid, Boundaries (Auto), Text/Icon Size (Small), Names, Nav-aids & Light Sector On, Attention areas, Projected course (30 min), CDI scale (0.1 nm), Land & Sea, Water features, Object depths, Spot soundings, Sounding min (0 ft), Sounding max (10 ft), Tidal stream, Land features, Land elevation, and Security navigation zone (Enabled, Value 10 ft). The third screenshot shows the 'S-MAP' settings menu with options: Chart, Rotation (Heading up), Palette (Sunlight), General, Land & Sea, Map Datum (WGS84), NMEA datum offset (Off), Map shift (Off), Restore default, Sat/Lon grid, Depth Digit, Lighthouse, Buoy, Wreck Ship, Fish Haven, Sea Lane, Restricted Area, Fishing Area, Sea Cable, Name, Mark Attribute, Sea Sector No, EEZ Area, Projected course (30 min), and CDI scale (0.1 nm).

4-2-1 Rotation

Three types of display presentations are provided. The default is heading up.

North up: North is at the top of the display.

Heading up: When course is set, the course is at the top of screen all the times.

Course up: When destination is set it is at the top of the screen.

4-2-2 Palette

Palettes are used to enhance the visibility of the display depending on the surrounding light environments. Four types of displays are provided; Normal, NOAA, Sunlight and Night.

4-2-3-1 General (NAVIONICS)

Plotter mode: this mode allows you to zoom in and out at scales where cartographic data are not available.

Mixing levels: when the map coverage at the current chart scale does not fill the entire display, the GPS chart plotter draws the rest of map using charts from above and below the current scale. When this function is turned on you will notice the display may redraw 2 to 3 times to show all the detail.

Nav-aids: The way to display fog, radar and radio station signals. (International and US)

Attention areas: Turns the displaying of Attention Areas where need to pay attention more) On or Off.

Text/Icon Size: change the size of text and icon on the chart.

Names: Display area names in the chart.

Nav-aids & Light Sector: Turns the presentation of Light, Signals, Buoys and Beacons On, Off, No Sector (Nav-Aids are shown, Light Sectors are hidden) or Animated (The lights are flashed).

4-2-3-2 Land & Sea (S-MAP)

Lat/Lon grid: Turns the displaying of Lat/Lon on or off

Depth Digit: Turns the displaying of water depth on or off

Lighthouse: Turns the displaying of Lighthouse on or off

Buoy: Turns the displaying of buoys on or off

Wreck Ship: Turns the displaying of Wreck Ship on or off

Fish Haven: Turns the displaying of Fish Haven on or off

Sea Lane: Turns the displaying of Sea Lane on or off

Projected course: Display the Projected course in given set time.

CDI scale: Set CDI (Course Deviation Indicator) scale which is a parallel line on either side of the plotted course.

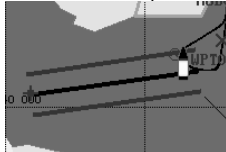

AntiClutter: when this option is selected, less important information (names & icons) are hidden when they are overlapped.

Value added data: The Value Added Data (VAD) is a collection of additional cartographic objects which are not present on the original paper chart.

These objects have been obtained from other sources and then merged to the electronic charts in order to provide more information useful for the navigation.

Lat/Lon Grid: Turns the displaying of the latitude and longitude grid lines on or off on the chart window.

Boundaries: Turns the displaying of chart boundaries on, off or auto mode which shows the chart boundaries of the two charts below the current scale.

4-2-4-1 Land & Sea (NAVIONICS)

Water features: Turns the displaying of sea bed nature and tide stations icon on or off.

Object depths: Turns the displaying of object depths on or off.

Spot soundings: Turns the displaying of spot sounding on or off.

Sounding min: Set the minimum depth limit to show depth sounding, bathymetric lines and depth area.

Sounding max: Set the maximum depth limit to show depth sounding, bathymetric lines and depth area.

Tidal stream: Turns the displaying of tidal streams on or off.

Land Features: Turns the displaying of land features on or off.

Land elevation: Turns the displaying of land elevations on or off.

Safe Navigation Area: Set the water depth for safe navigation and displaying safe navigation area in color.

on or off

Restricted Area: Turns the displaying of Restricted area on or off

Fishing Area: Turns the displaying of Fishing Area on or off

Sea Cable: Turns the displaying of Sea Cable on or off

Name: Turns the displaying of area name on or off

Mark Attribute: Turns the displaying of Mark Attribute on or off

Sea Sector No: Turns the displaying of Sea Sector No on or off

4-2-5 Map datum

This unit has a compatibility with most of major chart system and this option allows you to select a map datum. The default datum is WGS84.

Map datum Selection

- 1 Press and hold **MENU** and select chart icon
- 2 Select general and Map datum
- 3 Select a desired map datum

4-2-6 NMEA datum offset

When you select other Map datum different from WGS84, latitude and longitude will be different from WGS84'S coordinates and this might confuse other device such as VHF radio if connected to the unit. If this option is applied, latitude and longitude send on the unit NMEA output will be the same as coordinates in WGS84.

4-2-7 Map shift

Sometimes current position of own ship does not match with the current location on the chart. To correct this position error, you can apply a map shift.

Applying a map shift

- 1 In the Chart setup menu, press and hold **MENU** and select **Chart** icon.
- 2 Select Map shift to **ON**.
- 3 Move cursor to the actual position on the chart.
- 4 Press **MENU** and select **Set**.

Canceling a map shift

If you want to clear the map shift:

- 1 In the Chart setup menu, select **Map shift**.
- 2 Press **MENU** and select **Clear**.



4-2-8 Restore default

Returns every chart settings to default.



4-3 Sonar settings

Sonar feature requires a connection to depth transducer.

To go to the Sonar settings:

- 1 Press and hold **MENU**.
- 2 Select the sonar icon.

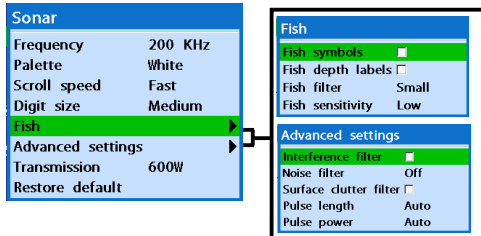

4-3-1 Frequency

You can select a sonar frequency among 200 kHz, 50 kHz or Mixed.

4-3-2 Palette

Palettes are used to enhance the visibility of the display depending on the surrounding light environments. Three types of displays are provided black, blue and white.

4-3-3 Scroll speed

You can set the scroll speed which determines how quickly the vertical scan lines run across the screen. Five speed options are provided; Very Fast, Fast, Medium, Slow and Pause.

4-3-4 Digit size

You can change the size of the depth window on the Sonar window. Three options are available Small, Medium or Large.

4-3-5 Fish

Fish symbols: Turn the fish symbol on or off.

Fish depth labels: Turn the fish depth value on or off.

Fish filter: Select a minimum fish size that will be displayed as a fish symbol.

Fish sensitivity

Select the minimum strength fish echo that will be displayed as a fish symbol.

4-3-6 Advance Settings

Interference filter: Interference from other equipment operating nearby or on your boat may show itself on the display. Use this option to remove interference.

Noise filter: If there is noise, the echo signal from transducer is not stable. This function remove noise and averages the echo signal. However, this option may also remove fish echoes.

Surface clutter filter: This filter removes surface noise. However, the function does not remove fish echoes.

Pulse length: You can select specific pulse length of transducer. A short pulse shows more detailed information but can't show deeply into the water because of less power. The Auto setting is recommended.

Pulse power: You can select specific pulse power of transducer. Low power shows a clear display but can't show deeply into the water. The Auto setting is recommended.

4-3-7 Restore default

Returns every sonar settings to default.



4-4 GPS Settings

To go to the GPS settings:

- 1 Press and hold **MENU**.
- 2 Select the **GPS** icon.

| GPS | |
|---------------------------|------------|
| GPS source | External |
| DGPS source | WAAS/EGNOS |
| Static navigation | Off |
| Speed filter | 5 |
| Course filter | Off |
| Lat/Lon d.p's | 3 |
| Ship speed | Mid |
| Magnetic Variation | |

| Magnetic Variation | |
|--------------------|--------------------------|
| Enabled | <input type="checkbox"/> |
| Value | 00.0 'E |

When the GPS device is connected properly, the GPS settings provide the access to GPS functions and features connected with the satellites information used for further navigational information.

4-4-1 GPS Source

Select a source of GPS signals

Internal: Select this option when uses the internal GPS antenna.

NMEA0183 & NMEA2000: Select this option when using an external GPS or DGPS antenna via NMEA.

4-4-2 DGPS Source

Select WAAS/EGNOS when you want to utilize DGPS.

4-4-3 Static Navigation

This option is very useful when the boat stops or moves very slowly. This option allows you to set a minimum speed at which movement is assumed. The value range is from 0.00 to 9.99.

4-4-4 Speed Filter

Occasional waves and wind at sea affect the boat speed. In order to have stable boat speed, the unit calculates these factors to give the value of stable speed information.

4-4-5 Course Filter

Occasional waves and wind at sea affect the boat course. In order to have stable boat course, the unit calculates these factors to give the value of stable course information.

4-4-6 Lat/Lon d.p's

Select number of last digit of Lat/Lon to be sent to other marine electronics.

4-4-7 Ship speed

To have more precise boat speed and course, you can select your boat speed. Mid is highly recommended option for the most of common boat.

4-4-8 Magnetic Variation

This option compensates the difference between true north and magnetic north.



4-5 Track & Log Settings

To go to the tracking and long settings:

- 1 Press and hold **MENU**.
- 2 Select the **track & log** icon.

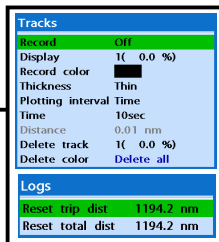
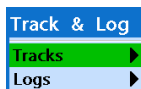

The unit has the capability to store 10 individual tracks and record up to 15,000 track points. Before using the track function you will need to setup the track function that suits your boat.

4-5-1 Track

Record

Off: Stop a recording of Track 1 to 10 (select a track number): Start a recording of the boat's course.

Display

Off: Display no track on the chart.
1 to 10 (select a track number): Display a selected track on the chart.

Record color

Select the color of recording track.

Thickness

Select the thickness of recorded track.

Plotting Interval

Select the method of plotting interval between time and distance.

Distance

Select the distance of plotting interval.

Time

Select the time of plotting interval.

Delete track

Delete a selected track record.

Delete color

Select the color of deleting track.

4-5-2 Log

Reset trip dist

Shows you the trip distance. If you select this option it resets the trip distance.

Reset total dist

Show you the total trip distance. If you select this option it resets the total trip distance.

4-7-1 Display Filter

There are a couple of methods to filter AIS vessel in this unit as below.

Filter by Type : The type of vessel which is selected will not be displayed on the chart.

Filter by distance : Vessels outside the radius of selected distance from own ship is filtered.

4-7-2 Alarm Option

Dangerous Vessel Alarm : When this option is selected an alarm will activate. Even this option is not selected; dangerous vessels will still be on the chart.

TCPA Limit : Set the Time of Closet Point of Approach limit.

CPA Limit : Set the Closet Point of Approach limit.

Proximity alarm : Trigger an alarm when any AIS equipped vessel is within a set proximity radius.

Proximity radius : Set a radius for proximity alarm.

Filter by speed : Vessels with speed below the set value are filtered.

Show Dangerous Only : When this option is selected, it shows dangerous vessel only.

4-7-3 Display Option

Projected course : Set a time for projected course. The project course show the estimate course of vessel base on the given time.

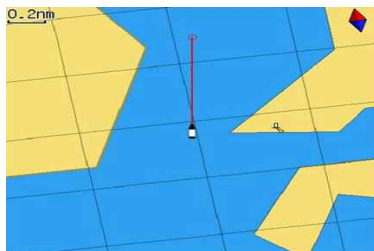

Range rings : Select a number of Range rings.

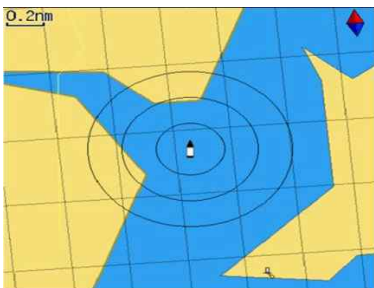

4-7-4 Restore Default

Returns every AIS setting to default.



4-8 Alarm Settings

Press long **MENU** then select **Alarms**:

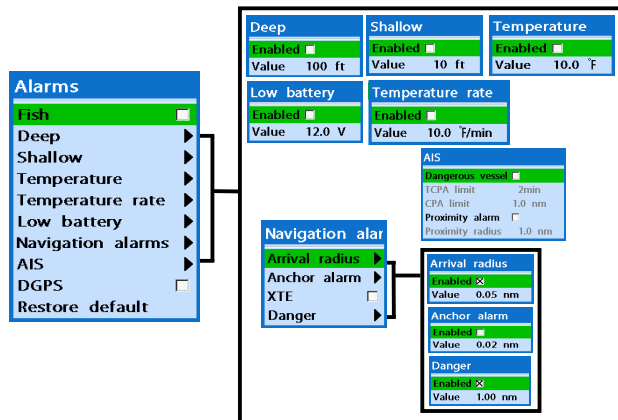

A warning message with beep sound is displayed when an alarm condition is met by user setting. Press **ESC** to clear the alarm. However, the alarm will be displayed again when the alarm condition occurs again. The unit provides alarms for various functions.

4-8-1 Deep

Trigger an alarm when the depth value received from the transducer is deeper than a set value.

4-8-2 Shallow

Trigger an alarm when the depth value received from the transducer is shallower than a set value.

4-8-3 Temperature

Trigger an alarm when the reported temperature from the transducer is same as a set value.

4-8-4 Temperature rate

Trigger an alarm when the rate of temperature change from the transducer is same as a set value.

4-8-5 Low battery

Trigger an alarm when battery voltage is lower than a set value.

4-8-6 Navigation alarms

Arrival radius : Trigger an alarm when your boat is approaching the destination to set value

Anchor alarm : Trigger an alarm when your boat moves more than set valve

XTE : Trigger an alarm when your boat moves off the current CDI scale.

Danger : Trigger an alarm when your boat is getting closed to dangerous point.

4-8-7 AIS

See the Alarm option of 4-7 (AIS Settings).

4-8-8 DGPS

Trigger an alarm when DGPS signal is not received.

4-8-9 Restore default

Returns every alarm settings to default.



4-9 Other settings

Press long **MENU** then select **Others:**

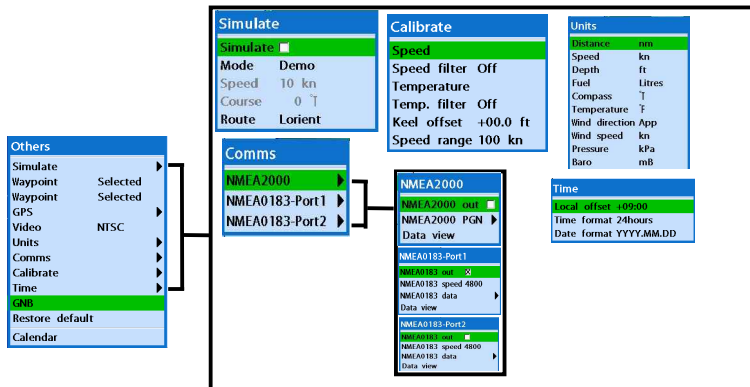

4-9-1 Simulate

Simulate :Turn the simulate mode on or off.

Mode : See 2-5 Simulate Mode.

Speed : The simulated boat speed to use.

Course : The simulated course over ground.

Route : The route to follow.

4-9-2 Waypoint

Select a way to display waypoints.

4-9-3 GPS

See 4-4 GPS Settings.

4-9-4 Video

Select the method of Video transmission method.

4-9-5 Units

Select a unit of each measure.

 **Tip:** Requires a optional VHF receiver with barometer connected: InHg or mB.

4-9-6 Comms.

Use this function only when it has been connected to the marine communication equipment through compatible NMEA. you may transmit NMEA data to other marine communication equipment. NMEA. NMEA interface is the made by following international standard which requires to be compatible with other marine communication equipment.

Select the Port(NMEA0183-Port1, NMEA0183-Port2, NMEA2000) and Transmission speed and select the demanded output information.

4-9-7 Time

Local offset : The time information supplied by the GPS satellites is in UTC (Universal Time Coordinates). To read the correct time, change the time of GPS chart plotter for daylight saving time start and end.

Time format : Select the format of time.

Date format : Select the format of date.

4-9-8 Electronic buoy

When electronic buoy has been connected, when you press  it will take you to the Electronic Buoy page, not the Data page. When you press menu, you may use individual call, display indication, Line indication or delete.

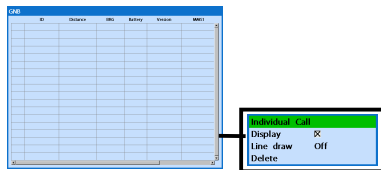

4-9-9 Restore default

Returns every other setting to default

5 CONNECTIONS

Accurate installation highly affects the performance of this equipment. You must read the manual on installation, antenna and other equipment information before installation process. For information on the additional equipment, contact SAMYUNGENC and check.

5-1 OPTIONAL PART

Optional sense and equipment

- External alarm
 - GPS or DGPS antenna
 - Transducer
 - MEDIA cable
 - Y cable
- DSC VHF wireless communication equipment
 - NMEA2000: Equipment can display the engine information and Trim information.
 - Others: Other equipment may input the information to this equipment, and the other way around.

Connection part

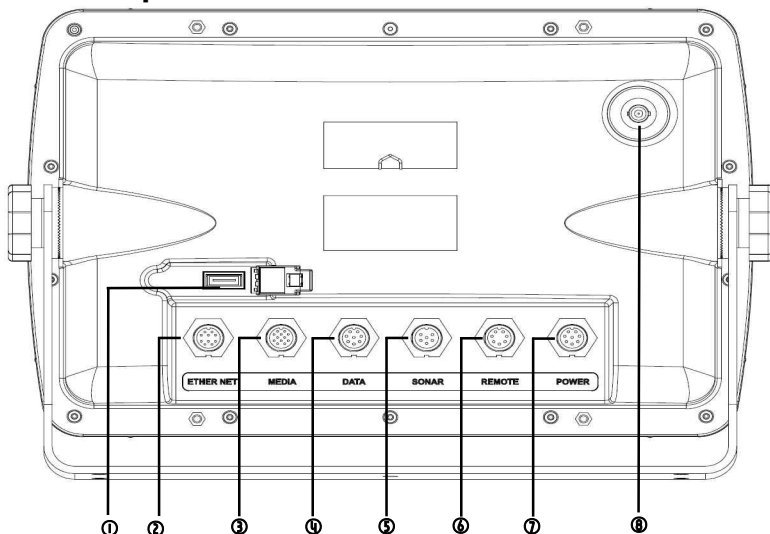

- ① HDMI : Use HDMI connection cable, connect external monitor
- ② ETHERNET : .
- ③ MEDIA : CCTV, S-VIDEO, external speaker, mic connect (Use optional MEDIA cable)
- ④ DATA : DGPS, NMEA2000 (Use optional Y cable)
- ⑤ SONAR : Connect 201B45 transducer.
- ⑥ REMOTE : Connect the external remote control REM-3D .
- ⑦ POWER&DATA : connect 11~36V DC power supply, NMEA0183, external alarm
- ⑧ External GPS : Connect SAN-60 .

[Number of Connector Pin]

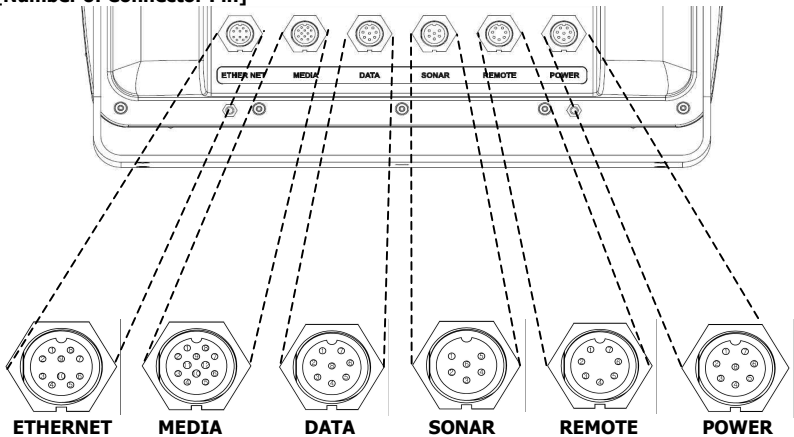

[POWER & DATA]

| Number of Pin | Color | Description |
|---------------|--------|---|
| 1 | BLACK | Enter -POWER |
| 2 | BROWN | NC |
| 3 | WHITE | NMEA0183 output |
| 4 | BLUE | NMEA0183 input |
| 5 | RED | +POWER input, 11 to 36V DC |
| 6 | ORANGE | NC |
| 7 | YELLOW | NMEA0183 GND |
| 8 | GREEN | output the external alarm, maximum 30V DC 200mA |

[SONAR]

| Number of pin | Description |
|---------------|----------------|
| 1 | SONAR+ |
| 2 | SPEED/TEMP GND |
| 3 | SPEED/+SUPPLY |
| 4 | TEMP |
| 5 | SONAR - |
| 6 | SONAR GND |
| 7 | DGPS_GND |
| 8 | DGPS_IN |

[REMOTE]

| Number of pin | Description |
|---------------|-------------|
| 1 | +5V |
| 2 | +5V GND |
| 3 | NC |
| 4 | RXD |
| 5 | LED_DIM |
| 6 | PWR_S.W |
| 7 | LED_DIM GND |

[DATA]

| Number of pin | Description |
|---------------|-------------|
| 1 | DGPS_OUT |
| 2 | +12V |
| 3 | +12V_GND |
| 4 | CAN_H |
| 5 | CAN_L |
| 6 | CAN_GND |
| 7 | DGPS_GND |
| 8 | DGPS_IN |

[MEDIA]

| Number of pin | Description |
|---------------|-------------|
| 1 | +12V_GND |
| 2 | AUDIO_GND |
| 3 | AUDIO_IN_R |
| 4 | AUDIO_OUT_L |
| 5 | AUDIO_GND |
| 6 | +12V |
| 7 | VIDEO_GND |
| 8 | VIDEO_GND |
| 9 | VIDEO_IN1 |
| 10 | AUDIO_OUT_R |
| 11 | AUDIO_IN_L |
| 12 | VIDEO_IN2 |

[ETHERNET]

| Number of pin | Description |
|---------------|-------------|
| 1 | RD- |
| 2 | RD+ |
| 3 | COMMON_1 |
| 4 | EXT_ON/OFF |
| 5 | PGND |
| 6 | COMMON_2 |
| 7 | TD- |
| 8 | TD+ |
| 9 | GND |
| 10 | SHIELD |

5-2 CONNECTION

GPS Chart plotter has the connection device to connect with the NMEA equipment like power supply, GPS antenna, AIS receiver, auto pilot device and digital equipment.

***Warning: Check that the power supply cable does not get connected to the REMOTE Connector or the DATA connector. If power supply cable gets connected to the other connector, this will seriously damage the equipment.**

5-3 Power supply & DATA cable

Manual Power supply

- For manual power supply, connect the equipment as below

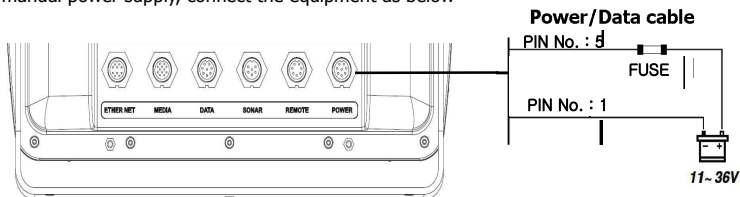

- *Use 7A/250V[30mmX6mm] fuse at 12V power supply
- Use 3A/250V[30mmX6mm] at 24V power supply.

5-4 Alert equipment

- To use the external alert equipment, connect it as shown below
- The maximum output from equipment to the external alarm is 30V DC 200mA, and you can create an environment using appropriate relay.

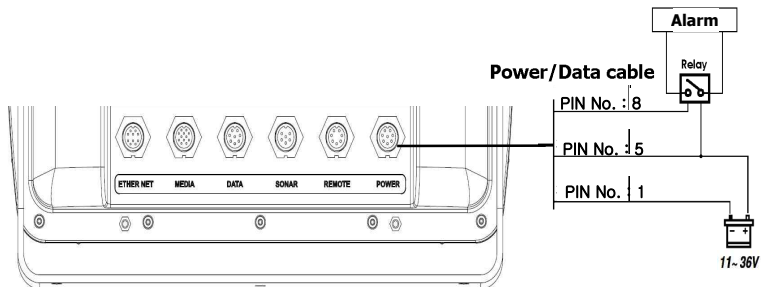

5-5 GPS ANTENNA

Selection of antenna

Install one of the GPS antennas from below.

5-5-1 External antenna

Internal GPS antenna's reception is affected by the place where equipment gets installed. If the internal GPS antenna's reception is poor, to enhance the GPS signal, you may connect the external GPS antenna. You may use BNC type of connector to connect.

Installing external antenna

In case of external antenna needed, install the external antenna and connect the antenna cable to the display unit. Install the antenna, and connect the optional cable if needed. System setting of the selected antenna is required while installing.

5-5-2 Internal antenna

The internal antenna is already equipped, therefore you may use the equipment without external signal input.

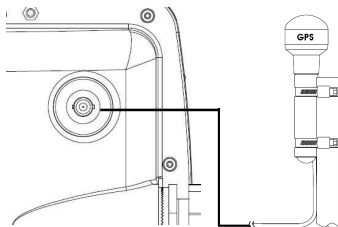

5-6 NMEA 0183

GPS chart plotter can be connected to the external equipment that uses NMEA0183 as below.

- DSC VHF Radio
- GPS antenna(NMEA 0183)
- NAVTEX
- AIS RECEIVER

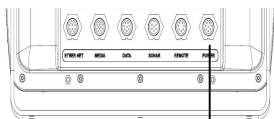

INPUT
NMEA 0183

PIN No. : 4 (Data in)
PIN No. : 7 (GND)

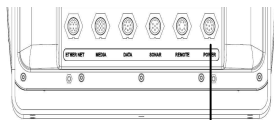

OUTPUT
NMEA 0183

PIN No. : 3 (Data out)
PIN No. : 7 (GND)

DSC VHF radio

Refer to the above NMEA 0183 picture to install the optional DSC VHF radio

Other NMEA Equipment

NMEA is the international industrial standard for internal connecting equipment. This equipment can be connected to the NMEA equipment. Refer to the above picture when

- Equipment may transmit the GPS location and navigational information to the auto pilot equipment or other equipment. Auto pilot equipment requires NMEA 0183 DATA (APB, APA, VTG).

Please contact SAMYUNGENC for detailed information of NMEA data.

When setting the other equipment to send

connecting other NMEA equipment.

- The equipment can receive information on paddlewheel, speed, temperature, depth of water from the optional equipment.
- Equipment may receive information from optional GPS or DGPS.

the NMEA data, select the NMEA output and be certain about NMEA data.

5-7 DATA

DGPS(NMEA0183), NMEA2000 could be used.

5-7-1 DGPS/NMEA ANTENNA

You can connect several equipment to one external GPS by receiving the GPS data in the form of NMEA from external equipment.

- When DGPS antenna is used, DGPS beacon antenna is optional when WAAS or EGNOS can't be used in a certain places in order to receive more accurate information based on specific beacon. When EGNOS is not usable, DGPS beacon antenna which provides more accurate information in area based on specific beacon is optional. DGPS antenna includes the GPS receiver and beacon receiver, and beacon correction value gets applied as GPS location information automatically.

To set the DGPS option(Non or WAAS/EGNOS):

Connect the GPS to the port and select the option. If GPS has been applied successfully, new set value will be displayed.

Caution:

Equipment may apply the WAAS, EGNOS DGPS correction value to the other GPS antenna.

You can acquire more detailed information by contacting SAMYUNGENC.

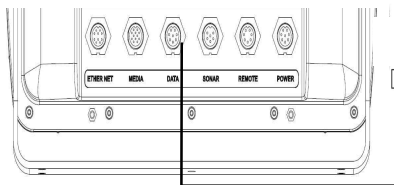

5-7-2 NMEA2000

NMEA 2000 regulation has been implemented for communication between navigational map, navigation, engine, tank level sensor and other marine electronic equipment. This is being defined by United State of America's NMEA.

This equipment may be connected to NMEA 2000 external equipment, and information as below may be displayed on the screen.

- Extra fuel sensor is not required as engine is equipped with the fuel sensor.
- Information on wind speed and direction from the optional equipment may be displayed.
- Information on depth of water may be received and displayed on the screen.
- Paddlewheel allows displaying information on velocity and temperature of water.

You must use the cable that meets the NMEA 2000 standard when connecting to the equipment.

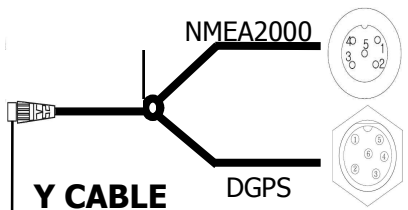

| Pin number | Description |
|------------|-------------|
| 1 | +12V_GND |
| 2 | +12V |
| 3 | CAN_GND |
| 4 | CAN_H |
| 5 | CAN_L |

NMEA2000 PIN MAP

| Pin number | Description |
|------------|-------------|
| 1 | +12V |
| 2 | +12V_GND |
| 3 | DGPS_OUT |
| 4 | DGPS_IN |
| 5 | NC |
| 6 | DGPS_GND |

DGPS PIN MAP

5-8 MEDIA

You may use CCTV, S-VIDEO, external speaker, microphone

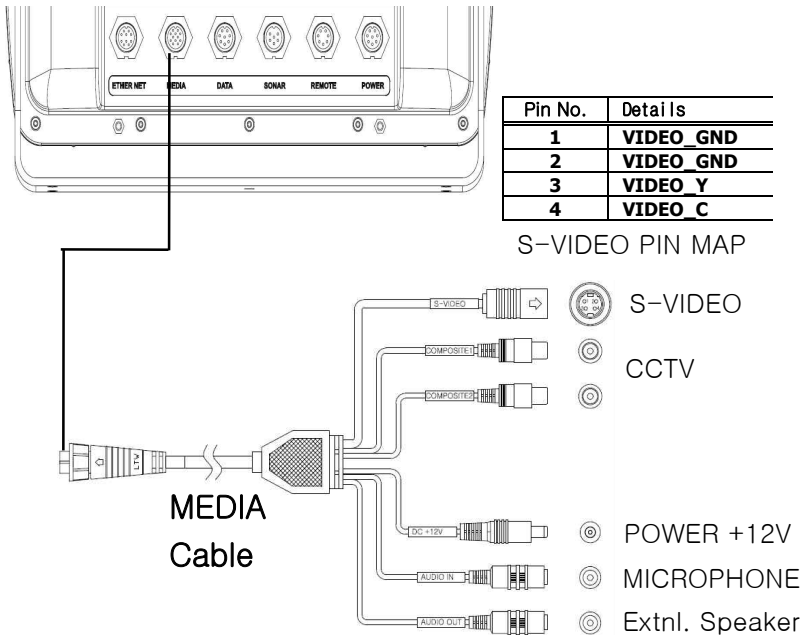

5-9 Set up and Test

- 1 You should place the rubber cover to the connector not in use at the back of the display unit. All connector must be connected to the plug and display unit must be installed at the right place.
- 2 If this equipment is set with bracket mounting, to optimize the view of screen, adjust the slope and rotate it and tighten the knob.
- 3 Insert the NAVIONICS card
- 4 Input the setting data to set the optional equipment as sensor or to adjust the equipment to meet your requirement.
- 5 From the Satellite information page, check that GPS satellite information displays. Wait until GPS satellite gets changed to 'Used in fix' and GPS receiver operates.

Menu Tree

Main menu

- 1. Introduction
 - 1-1 General Information
 - 1-2 Specification
 - 1-3 Components
 - 1-4 Optional accessories

- 2. Getting Started
 - 2-1 Installation
 - 2-1-1 Bracket mounting
 - 2-2 Button
 - 2-3 NAVIONICS SD Card, USB
 - 2-4 Selection of map
 - 2-5 Simulation
 - 2-6 Data bar
 - 2-7 Compass
 - 2-8 Multi display

- 3. General Operation
 - 3-1 Power on, off
 - 3-2 Brightness, night mode, background
 - 3-3 Main display
 - 3-4 Map
 - 3-4-1 Map display
 - 3-4-2 Longitude and Latitude
 - 3-4-3 Chart Scale
 - 3-4-4 NAVIONICS Search
 - 3-4-5 SAMYUNG MARP Search
 - 3-4-6 Symbol and information
 - 3-4-7 Navigational information
 - 3-4-8 Get to waypoint or point in a chart
 - 3-4-9 Follow the route
 - 3-4-10 Distance and bearing calculator
 - 3-4-11 Projected course
 - 3-4-12 Select mark from chart
 - 3-4-13 Set tracks from the chart display
 - 3-4-14 3D map
 - 3-5 Video
 - 3-5-1 Option
 - 3-6 Fishfinder
 - 3-6-1 Screen setting
 - 3-6-2 Mode
 - 3-6-3 Single or dual frequency fish finding
 - 3-6-4 Range
 - 3-6-5 Gain
 - 3-6-6 Fish finder
 - 3-6-7 No division of window
 - 3-6-8 Split enlargement or full screen zoom.
 - 3-6-9 Enlarge lowland
 - 3-6-10 Dual frequency display(50/200)
 - 3-6-11 A-Scope display

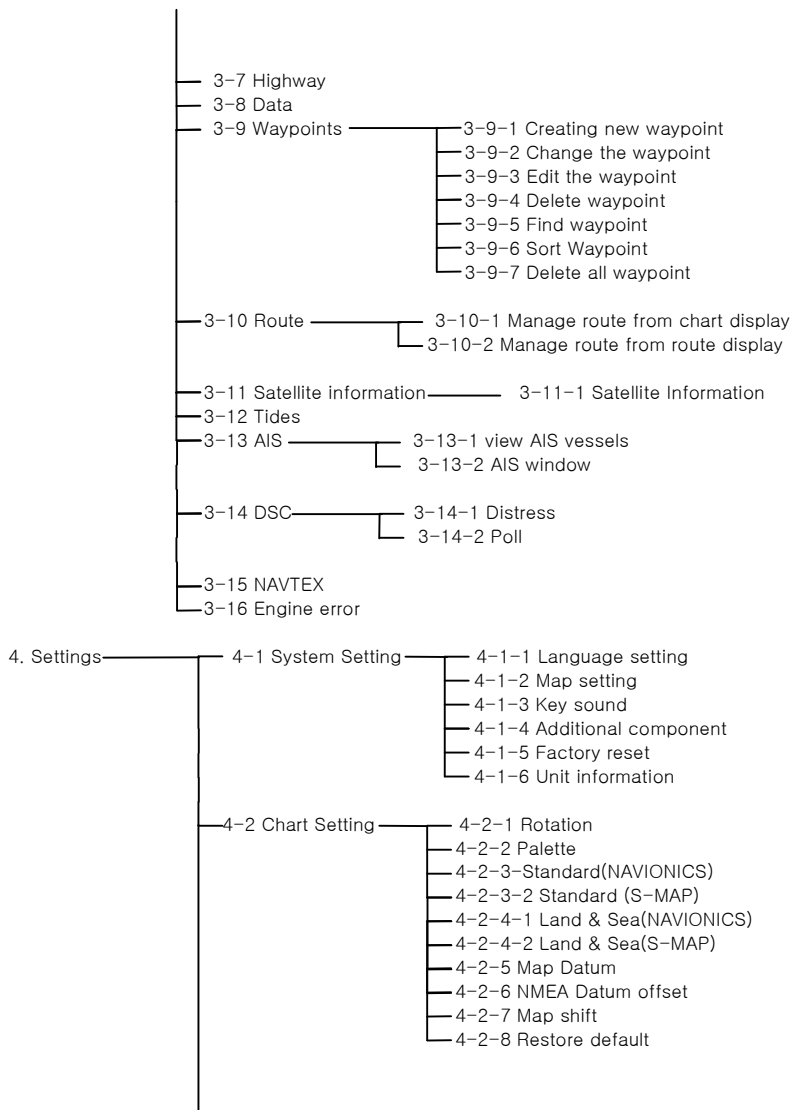

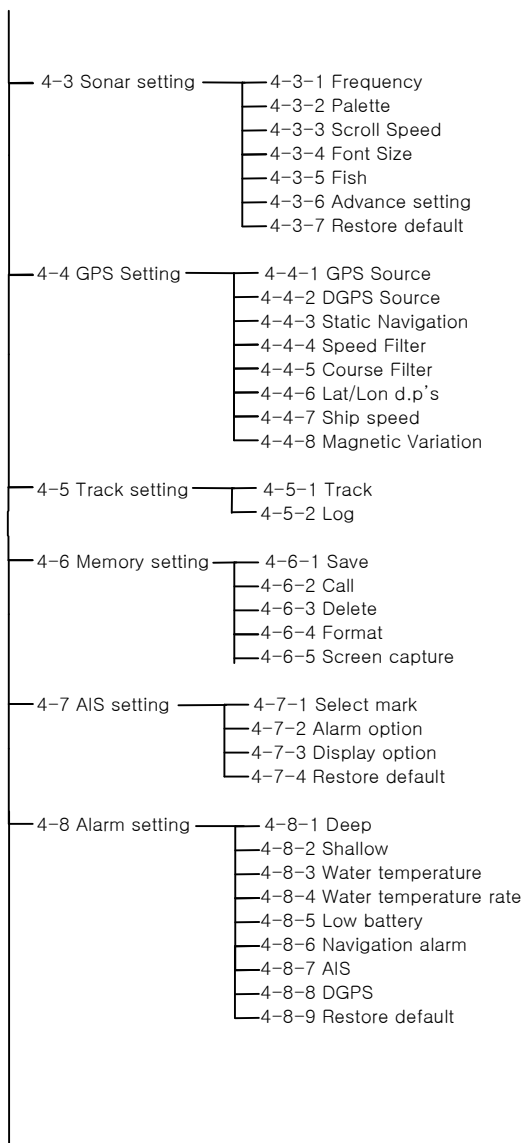

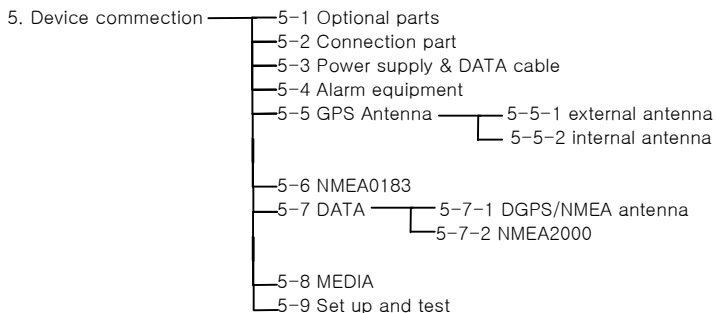
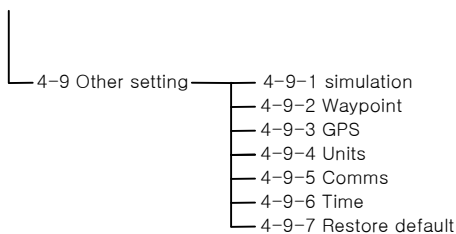

System Maintenance

In order to maintain the full function of equipment, regular maintenance and repair is compulsory. This includes regular checkup, software upgrade, and should at least include the below chart.

| Item | Contents |
|---------------------------------|--|
| Connector and terminal | Check the connectors and terminals on the back of the equipment are normally connected. |
| Cable | Check the conditions of the cables. If the cable has been damaged or disconnected, you must replace it. |
| Earth terminal, earth conductor | Check the conditions of the earth terminal. If it is rusty or decomposed, you must replace it or clean. Also check the connection of the earth conductor as well. |
| Maintain the equipment clean | <p>You must remove the dust from LCD using clean cloth. You must take extra care not to damage the LCD.</p> <p>When it has salt water or dirt, use clean tissue or cloth to remove it. Do not use the chemical to remove it as it may remove the color of surface or the writings on it.</p> |

※ Always update the electronic chart (Samsung Map)

Diagnosis

The chart explains the general symptoms of breakdown and solutions to it.

User should not disassemble equipment. The attempt may degrade the function of equipment or shorten the life of it. Therefore you take it to the professional engineer (A/S Center)

AS Center ☎ : 051-601-5570~5574, +82-51-601-5570~4

| Symptom | Solution |
|--|---|
| Power doesn't turn on | Check the power connector has been connected firmly. Check the power or fuse.. |
| Does not receive GPS satellite information | Check the connection of GPS antenna, Antenna cable and connectors. Check that the [GPS Port Setup] has been set as 'Internal'. |
| Display is Unstable or white stripe appears Display color changes | Check the connection condition of LCD connector. Clean the LCD connector's point of contact. |
| The position value error is large | Check if datum has been selected to 'WGS84'. If you have set latitude, longitude, correction function, set the value back to 0. |
| Vessel's speed value error is large | Adjust the smoothing function to set the value up for the vessel which is slow, and set the value low for the vessel which is fast. |
| Hard to distinguish the fish or seafloor due to the low gain. | Adjust the gain |
| Multiple seafloor appears | Adjust the gain |
| The record of fish or seafloor gets cut or uneven. | This may be due to the vessel's rolling, pitching or bubbles made by vessel's screw. |
| Transmitting line does not appear. | If the range [Position setup] has not been set to '0', adjust it to '0'. |

N100/NF100 Installation

1. If not connected to AIS, Autopilot, DGPS (Interconnect to the Power Cable 8P)

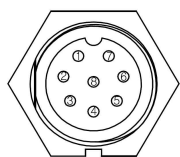

POWER

POWER CABLE (8P)

- 3. TX(WHITE) ↔
- 4. RX(BLUE) ↔
- 7. GND(YELLOW) ↔

GNB-400S

- RX(BLUE)
- TX(YELLOW)
- GND(WHITE)

EXT Power+RED

DC+10~36V

EXT Power-BLACK

2. When two equipment AIS and Autopilot are connected (Interconnect to the Data Connector LTW 8P)

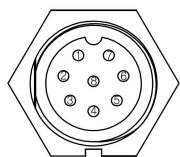

DATA

DATA CONNECTOR LTW(8P)

- 1. TX ↔
- 8. RX ↔
- 7. GND ↔

GNB-400S

- RX(BLUE)
- TX(YELLOW)
- GND(WHITE)

EXT Power+RED

DC+10~36V

EXT Power-BLACK

3. More than one of AIS or Auto Pilot have been connected and DGPS is under use.

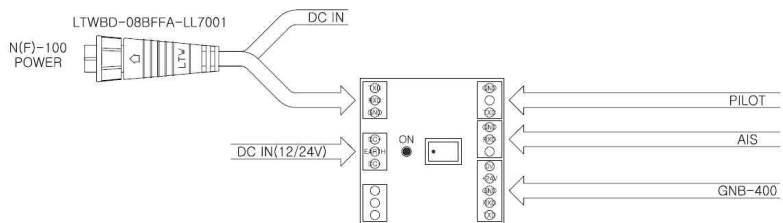

 **SAMYUNG ENC** 1 YEAR WARRANTY

Thank you for purchasing an SAMYUNG ENC product. This product has been thoroughly checked and is covered by the **Samyung ENC's warranty** for defects in materials and workmanship under normal use from the date of purchase.

This warranty provides for the free repair or replacement of defective parts from our Samyung ENC authorized dealer.

In the event that your SAMYUNG ENC product needs service, please return your SAMYUNG ENC product at your expense (shipping and insurance) to your Samyung ENC distributor or SAMYUNG ENC authorized Service Centres. SAMYUNG ENC will, at its discretion, repair or replace any defective products or its components at no cost to you. This is your exclusive remedy for defective products

Followings are not under Warranty .

1. Consumable items, including, but not limited to: fuses, impellers, impeller bearings, impeller shafts are specifically excluded from this warranty
2. All costs associated with transducer replacement, other than the cost of the transducer itself
3. As a result of incorrect installation, misuse, accident, water damage, abuse or other external causes
4. By modification or service other than by SAMYUNG ENC or authorized distributors, authorized Service Centres
5. If the serial number label on the unit has been removed, altered or mutilated

